

SMA Interferometry School 2020

Calibration I

Mark Gurwell, CfA

mgurwell@cfa.harvard.edu

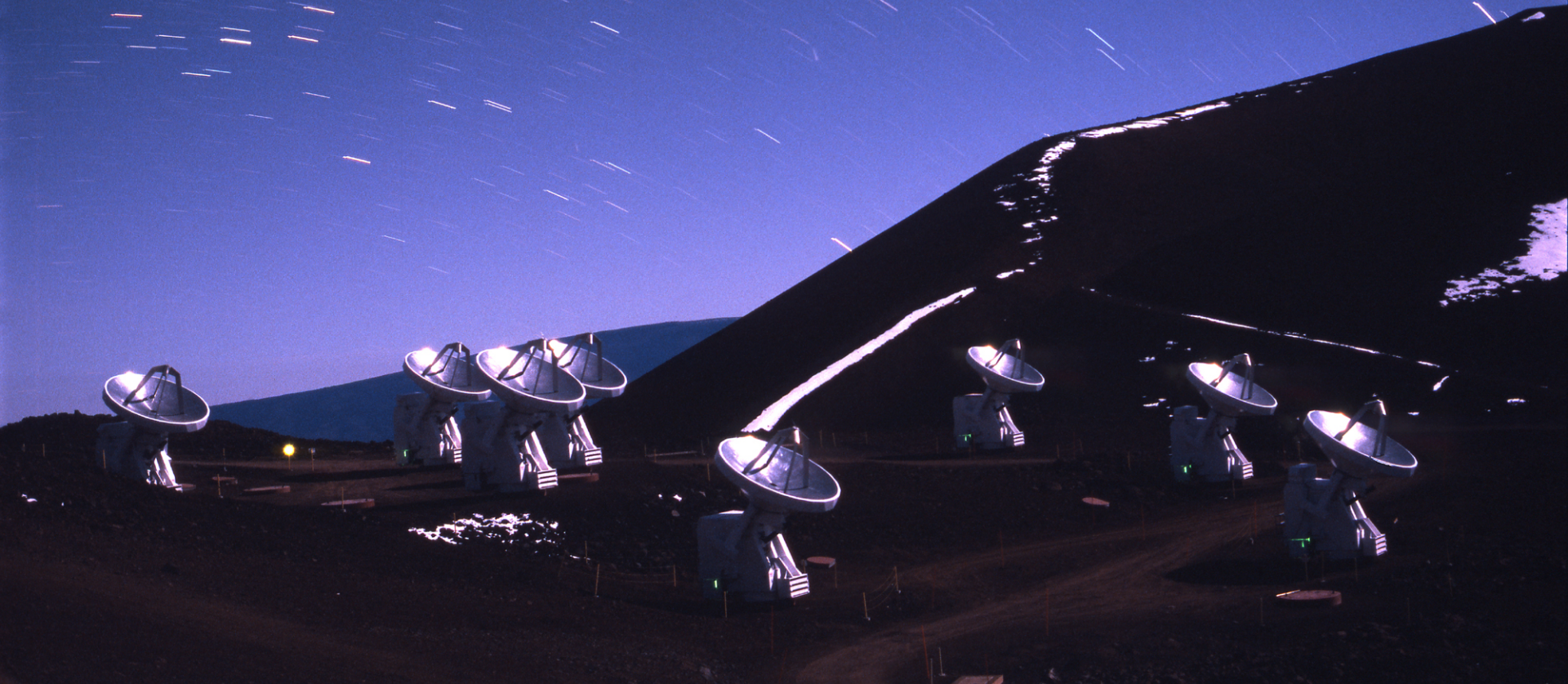

Synopsis:

What are the kinds of calibration needed to transform 'raw' visibility data (e.g. from the SMA) into scientifically useful visibility data, and from that to creating images?

That is, to go from data like this...

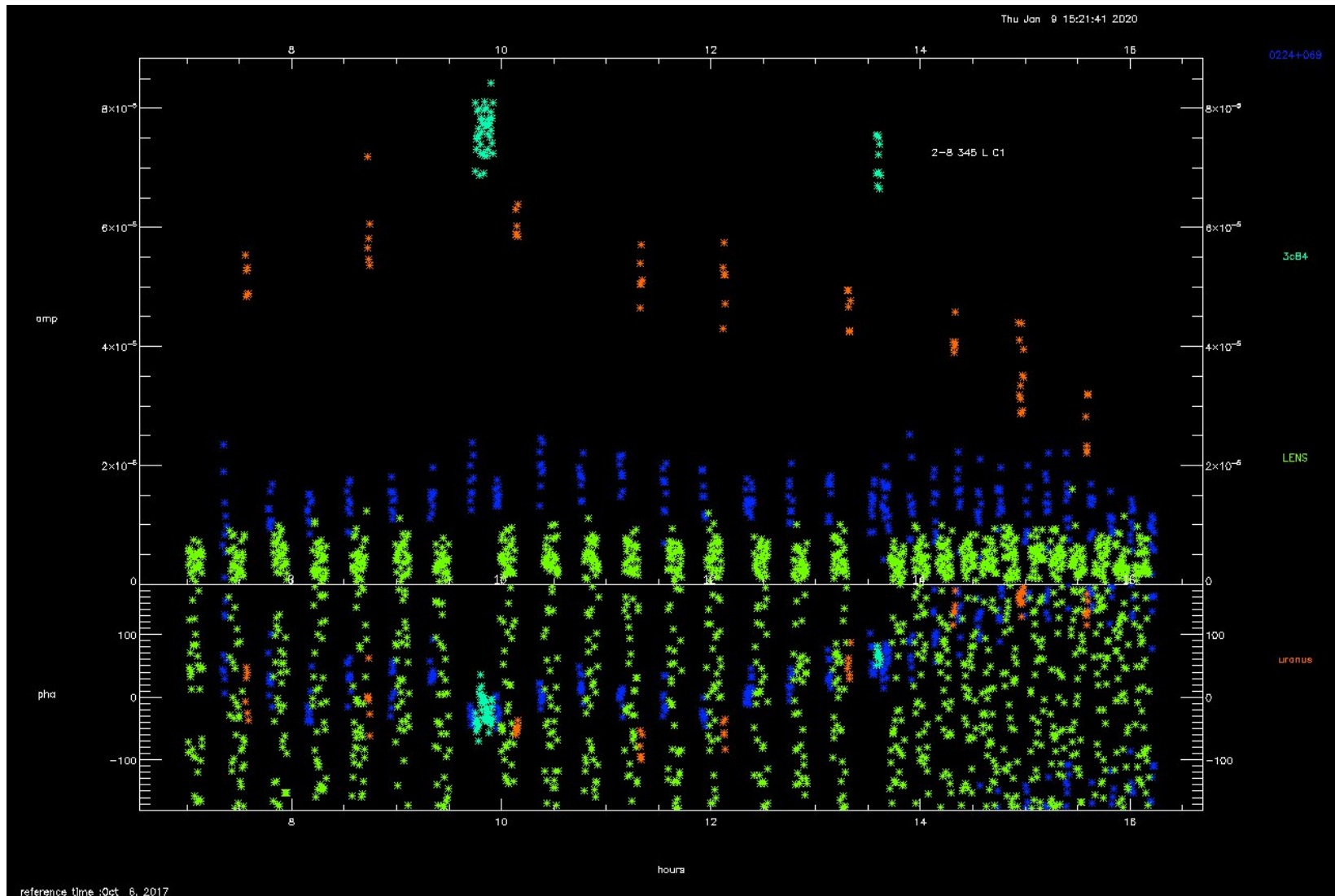

...to this,

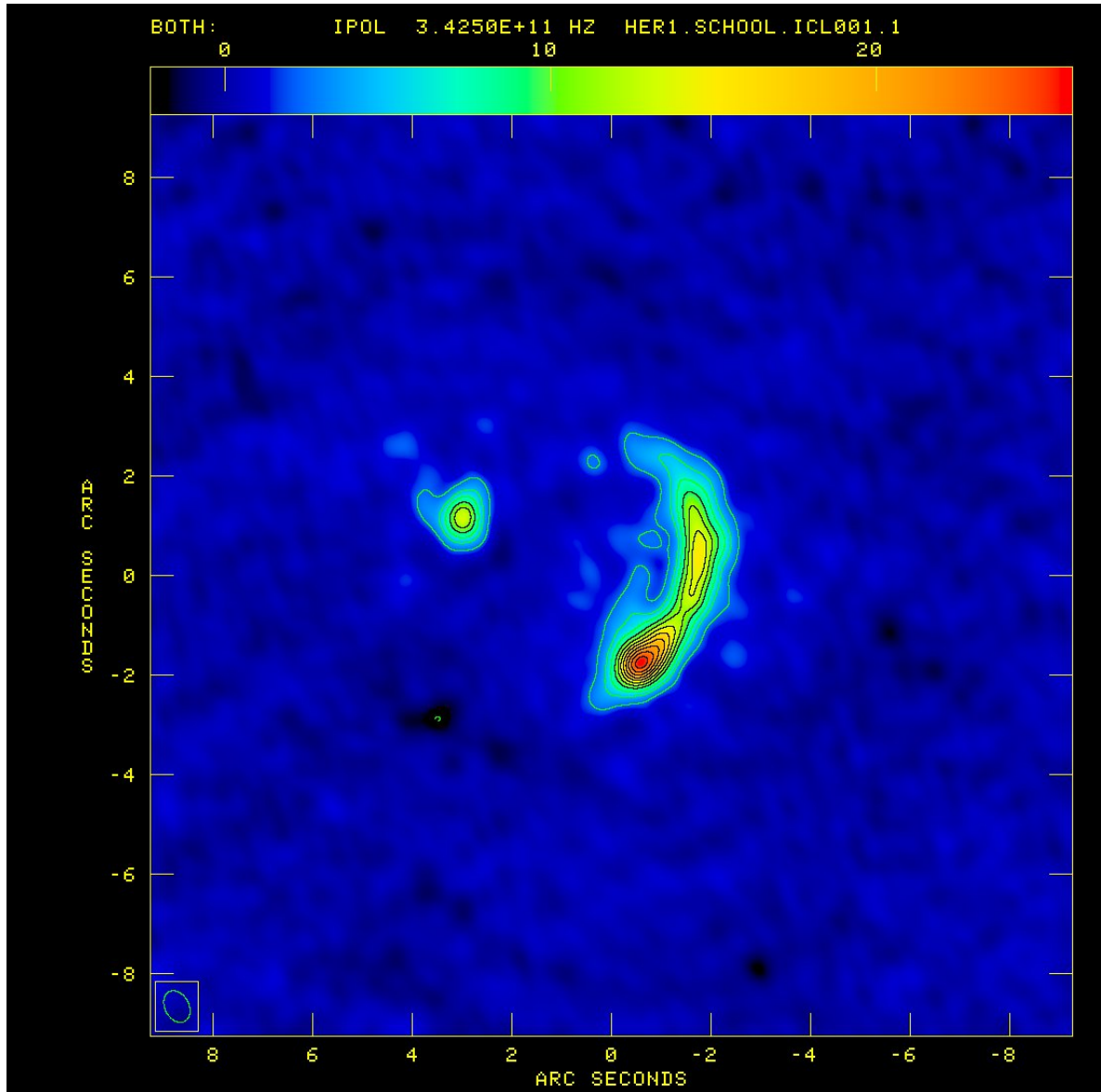

...instead of this.

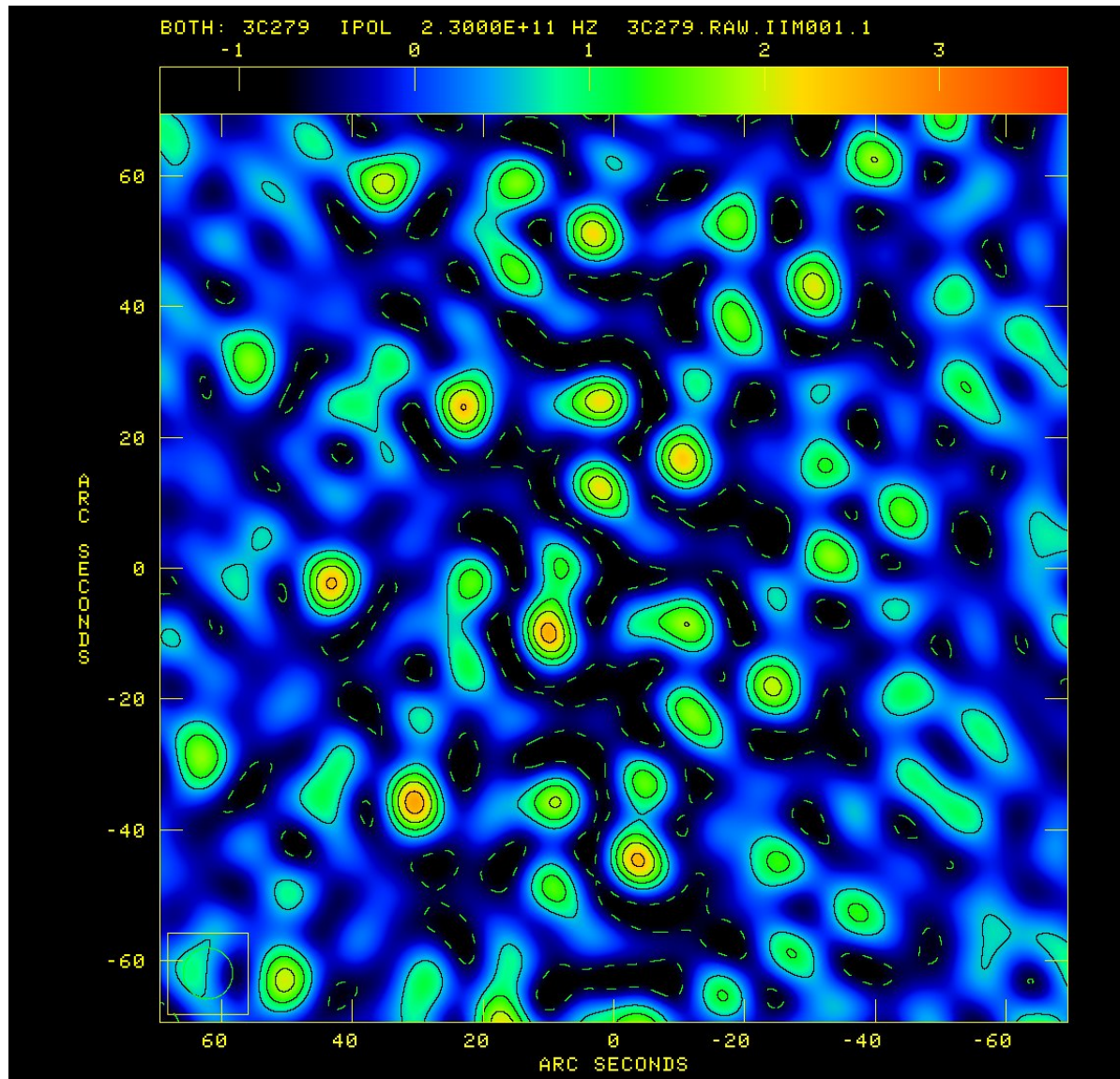

This one is better.

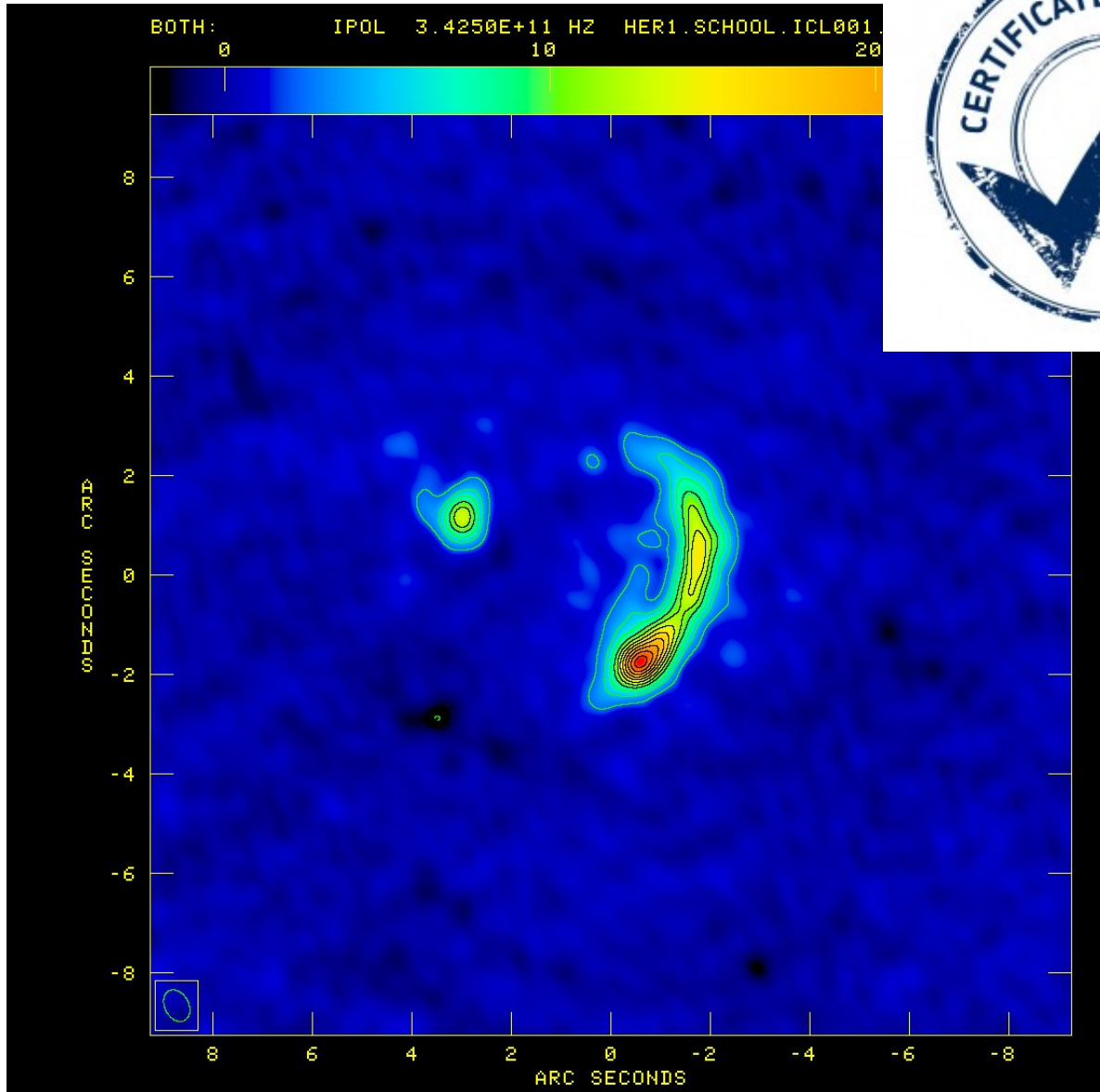

Outline

- Visibilities aren't 1-Dimensional, they're Complex
 - *two-element redux*
- What do I Gain from all this???
 - *what is a gain?*
 - *antenna-based gains and why they are a good thing*
- No Pains, No Gains
 - *Types of Gain Calibration*
 - *Tsys, Passband, Phase, Amplitude, Flux*

Incident monochromatic plane wave at angle Θ
(from a distant point source)

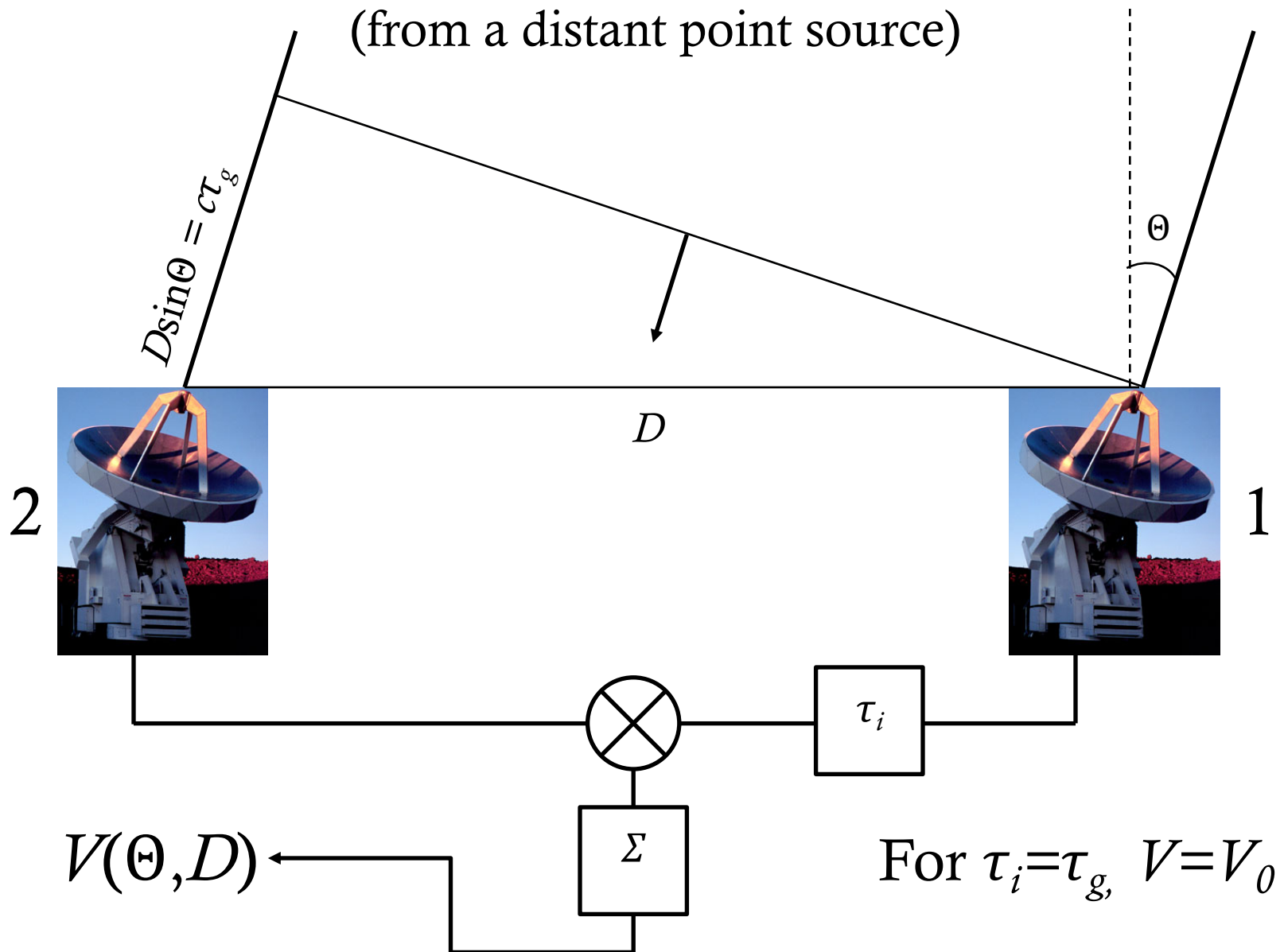

Incident monochromatic plane wave at angle Θ'

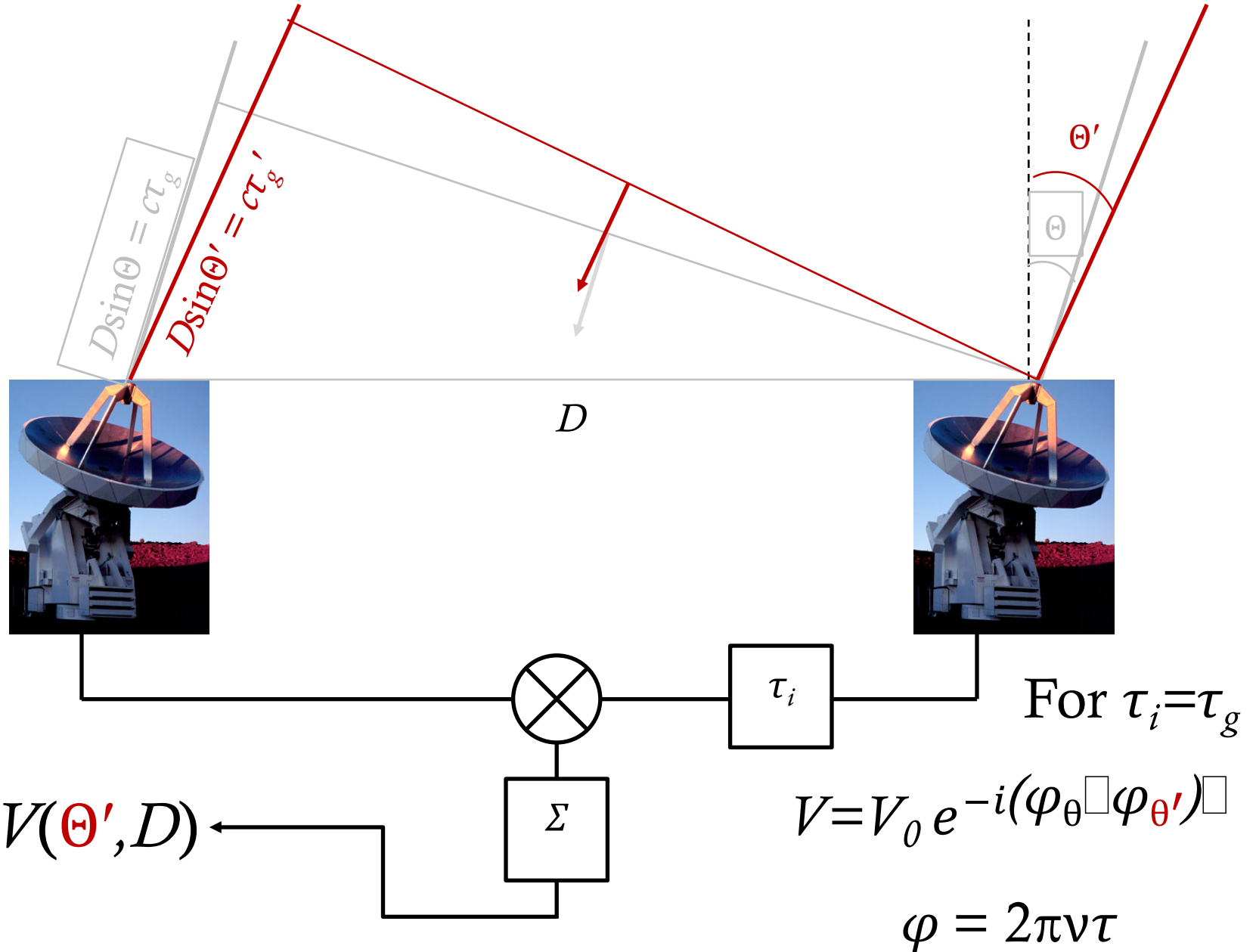

In practice, visibilities are more complicated than this, because they also depend on the emission distribution on the sky, as described in the **Van Cittert-Zernike Theorem**:

$$V_v(u, v) = \iint I_v(l, m) e^{-2i\pi(ul+vm)} dl dm$$

(You saw this earlier in Qizhou Zhang's talk).

Crucially, measured visibilities are also the result of modification by a variety of instrumental, environmental, and observing parameters that can affect both amplitude and phase.

Examples (not exhaustive!):

Errors in antenna positions

Offset errors in antenna pointing

Atmospheric opacity

Atmospheric turbulence/stability

Temperature sensitivity of system components

Spectral response of system

G_{jk} : complex 'gain' factor for each baseline jk (func. of time!)

$$\begin{aligned} V_{M,jk} &= V_{jk} G_{jk} + \sigma_{jk} \\ &= V_{0jk} e^{-i\varphi_{jk}} |G_{jk}| e^{-i\psi_{jk}} + \sigma_{jk} \end{aligned}$$

(σ_{jk} = measurement error)

Example – two-element interferometer with ‘antenna position error’

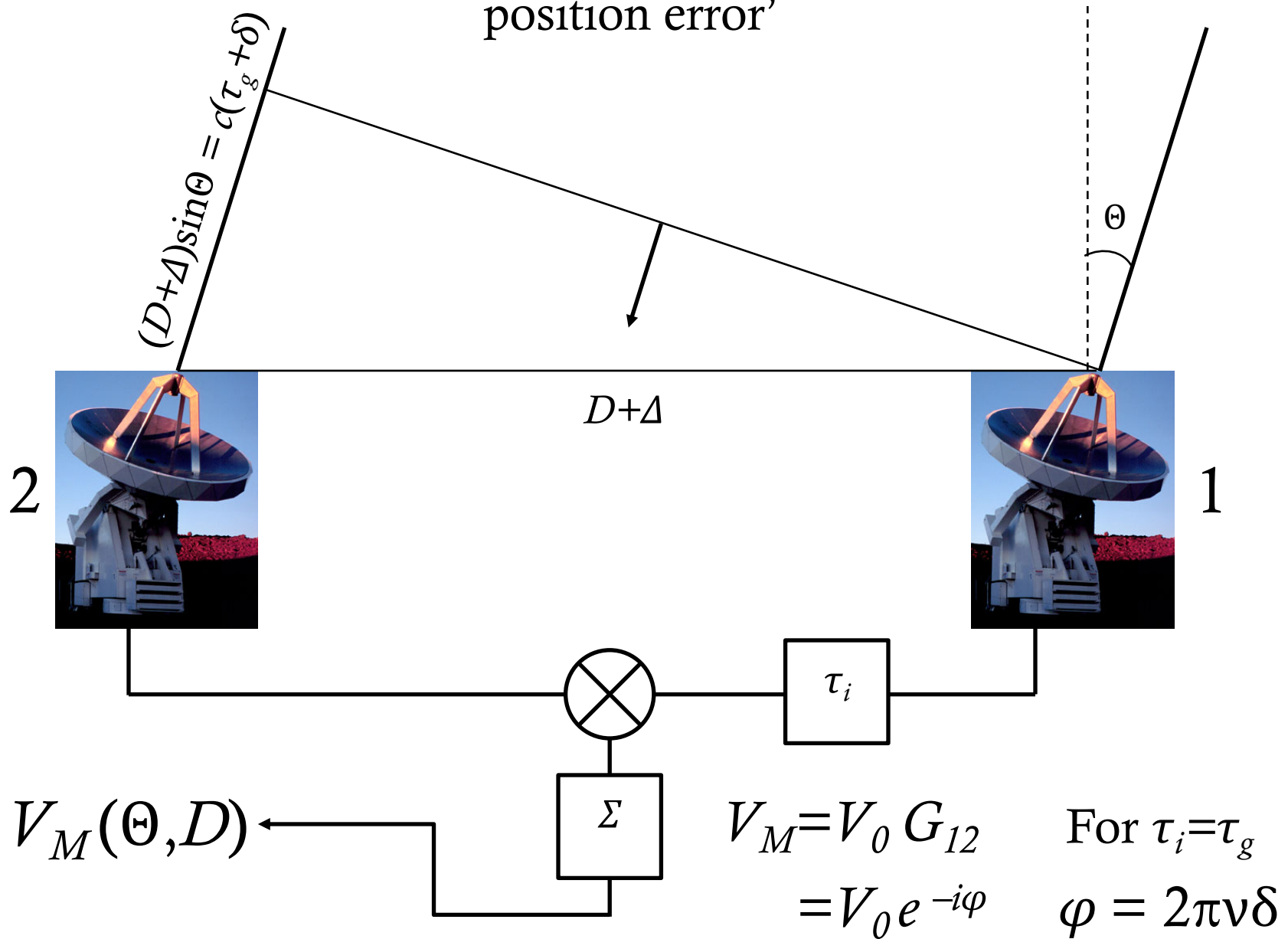

Example – two-element interferometer with ‘atmosphere’

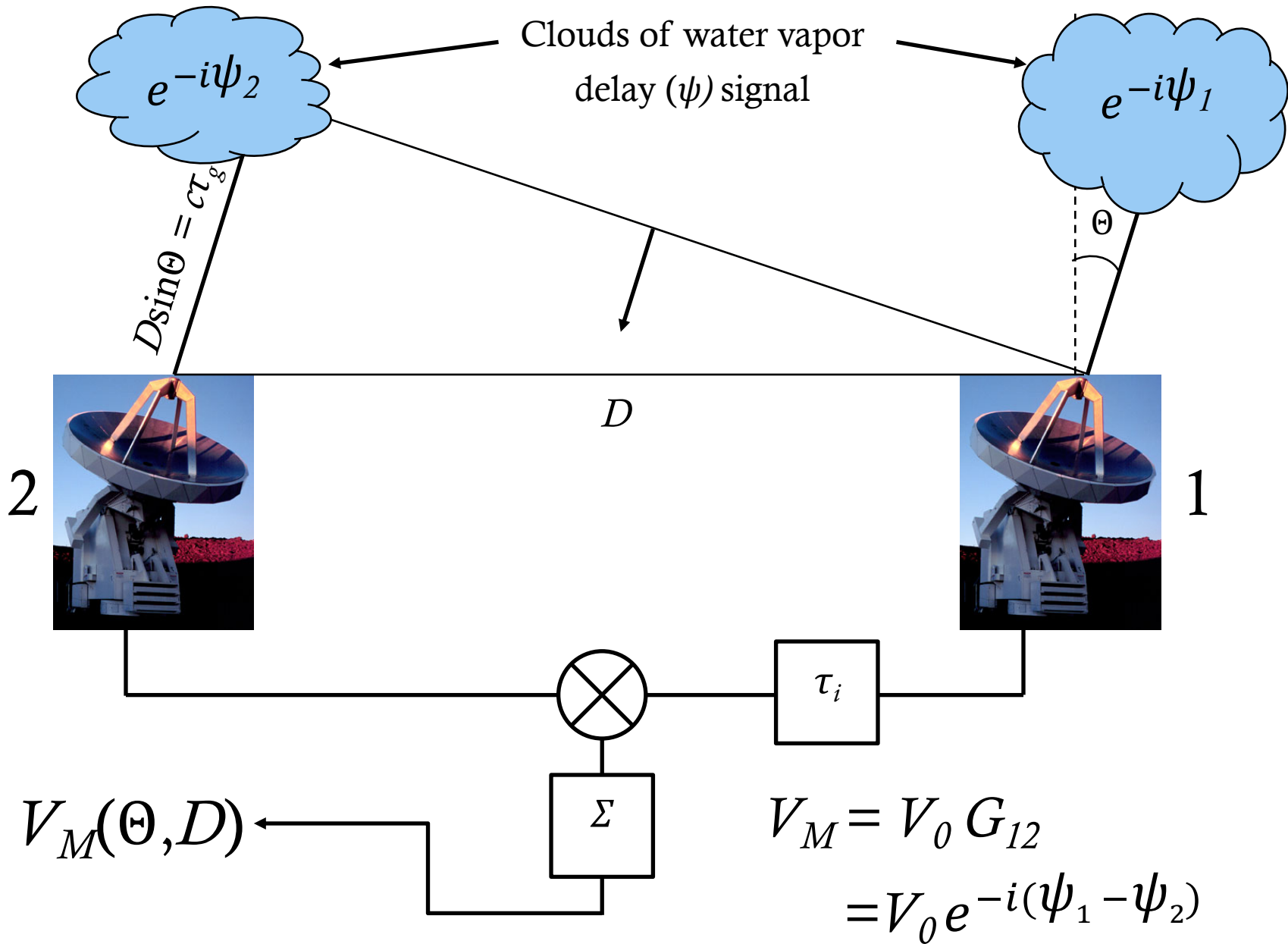

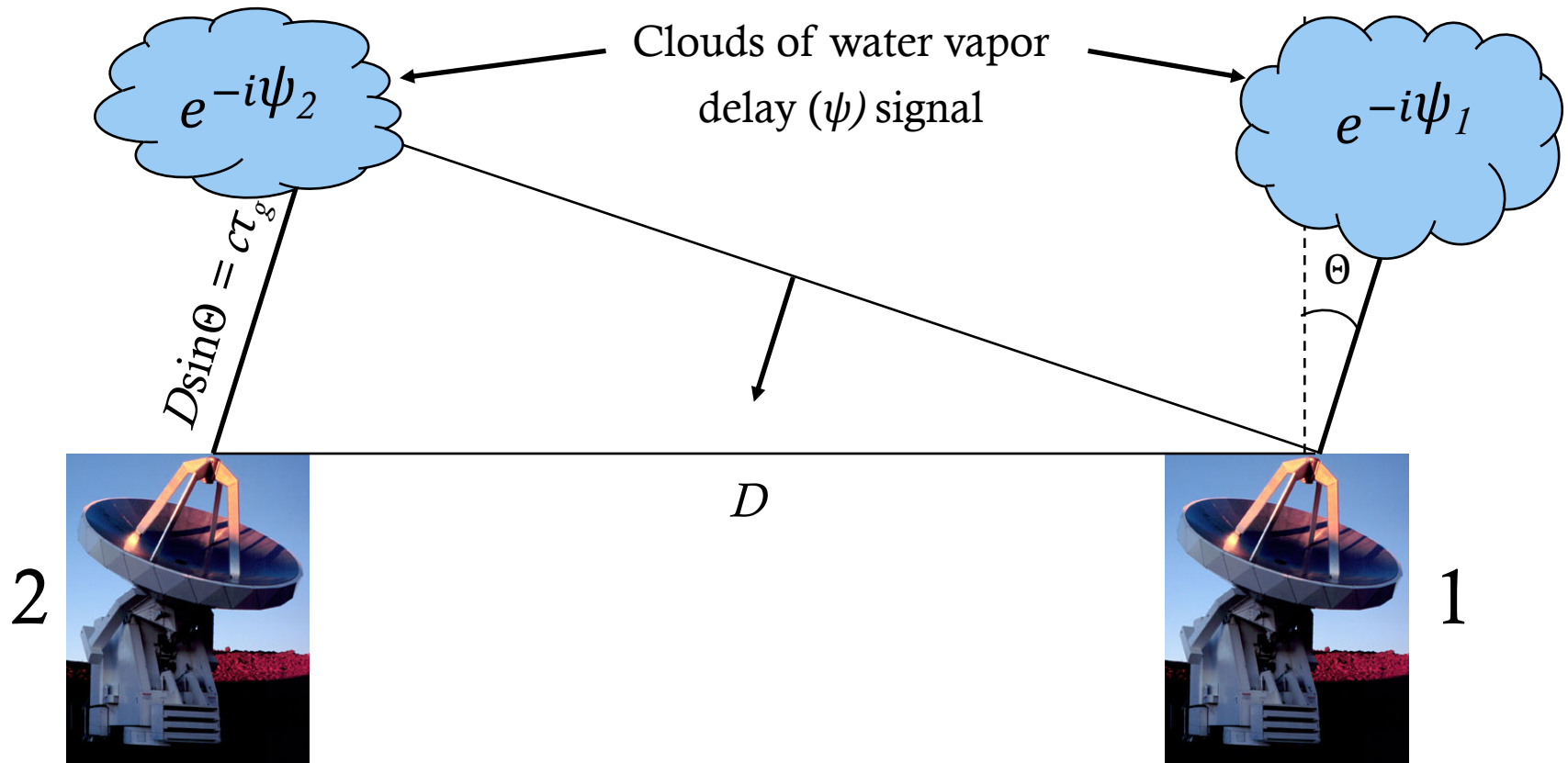

Note: Visibility has same form as when source is at an offset position

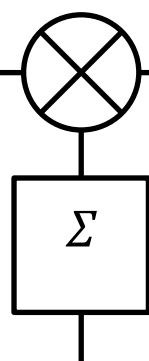

$$V_M = V_0 G_{12}$$

$$= V_0 e^{-i(\psi_1 - \psi_2)}$$

Incident monochromatic plane wave at angle Θ'

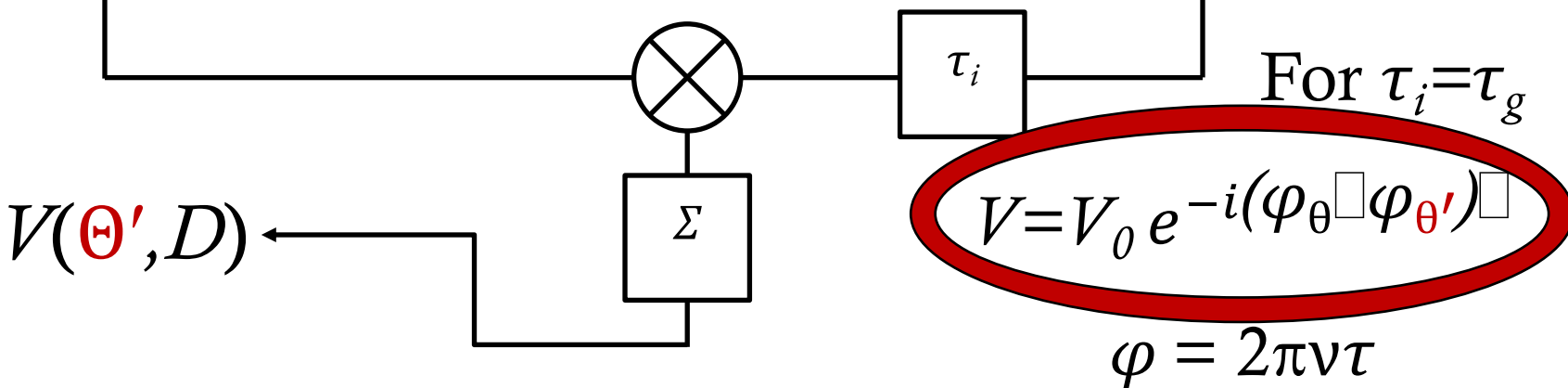
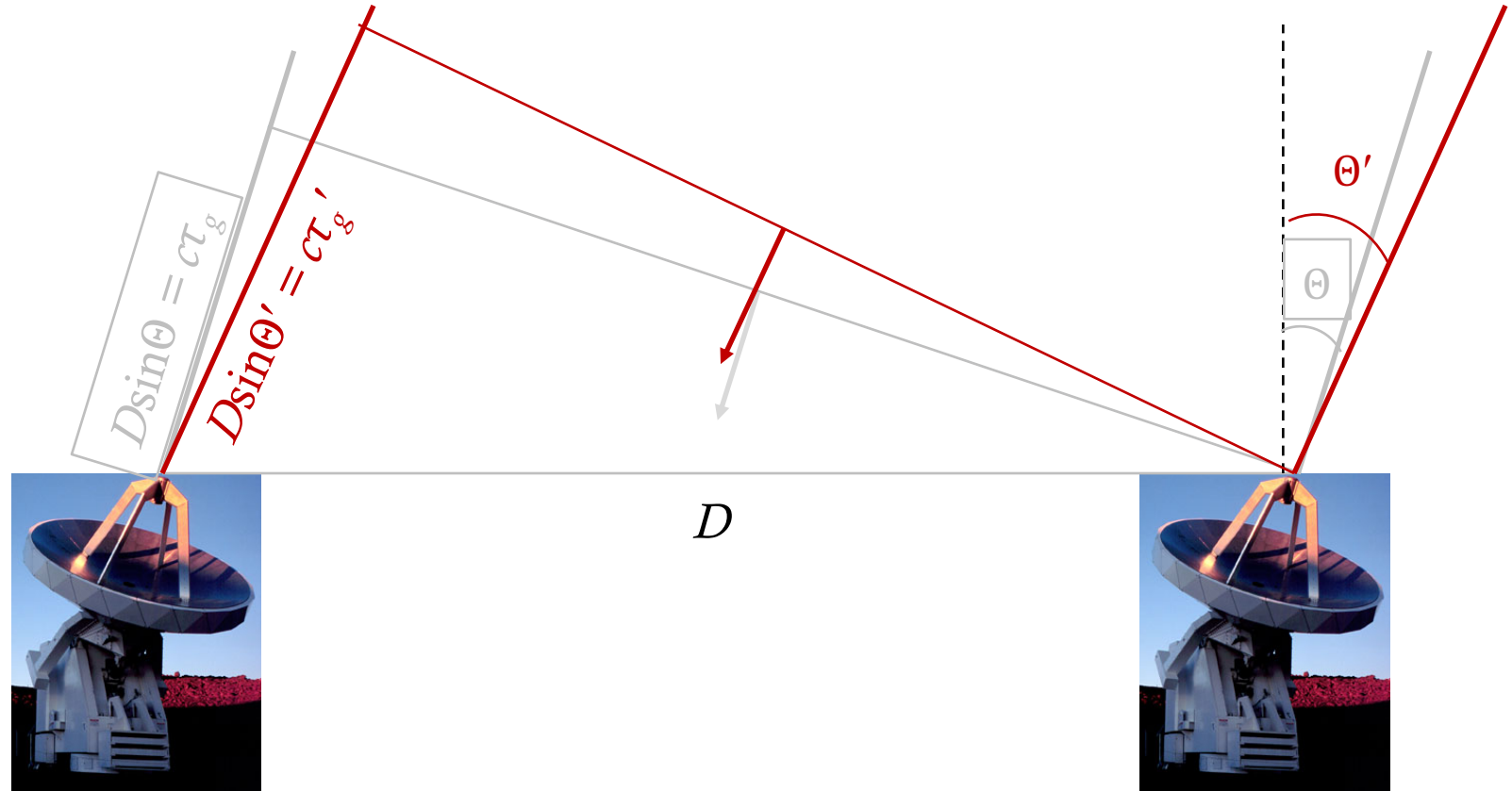

For $\tau_i = \tau_g$

$$V = V_0 e^{-i(\varphi_\Theta - \varphi_{\Theta'})}$$

$$\varphi = 2\pi\nu\tau$$

Example – two-element interferometer with ‘pointing’

Antenna primary beams not completely pointed in direction of incoming signal

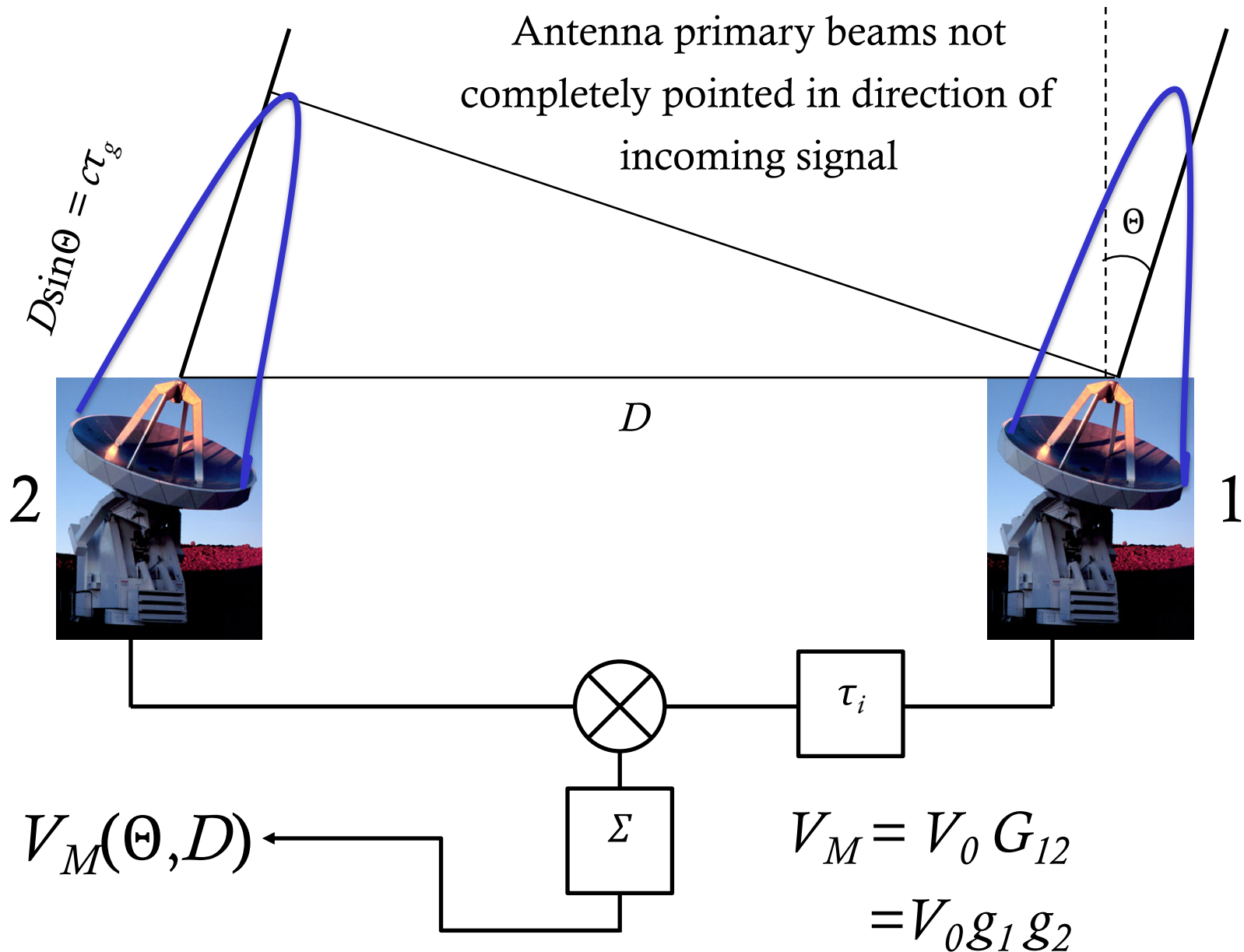

To best utilize and understand the data, need to correct, in the presence of measurement error/noise, for these gain variations

$$V_{Ojk} = V_{M,jk} / G_{jk}$$

This is the process of gain calibration

Nearly all processes contributing to gain affect the signal prior to cross-correlation. That is, they affect the signal from each antenna that comprises a baseline. Therefore, a baseline gain can be considered the linear combination of gains from two antennas.

$$G_{jk} \equiv G_j G_k$$

Why is that important?

Arrays typically have more than 2 antennas

$$\#_B = N_A(N_A - 1) / 2$$

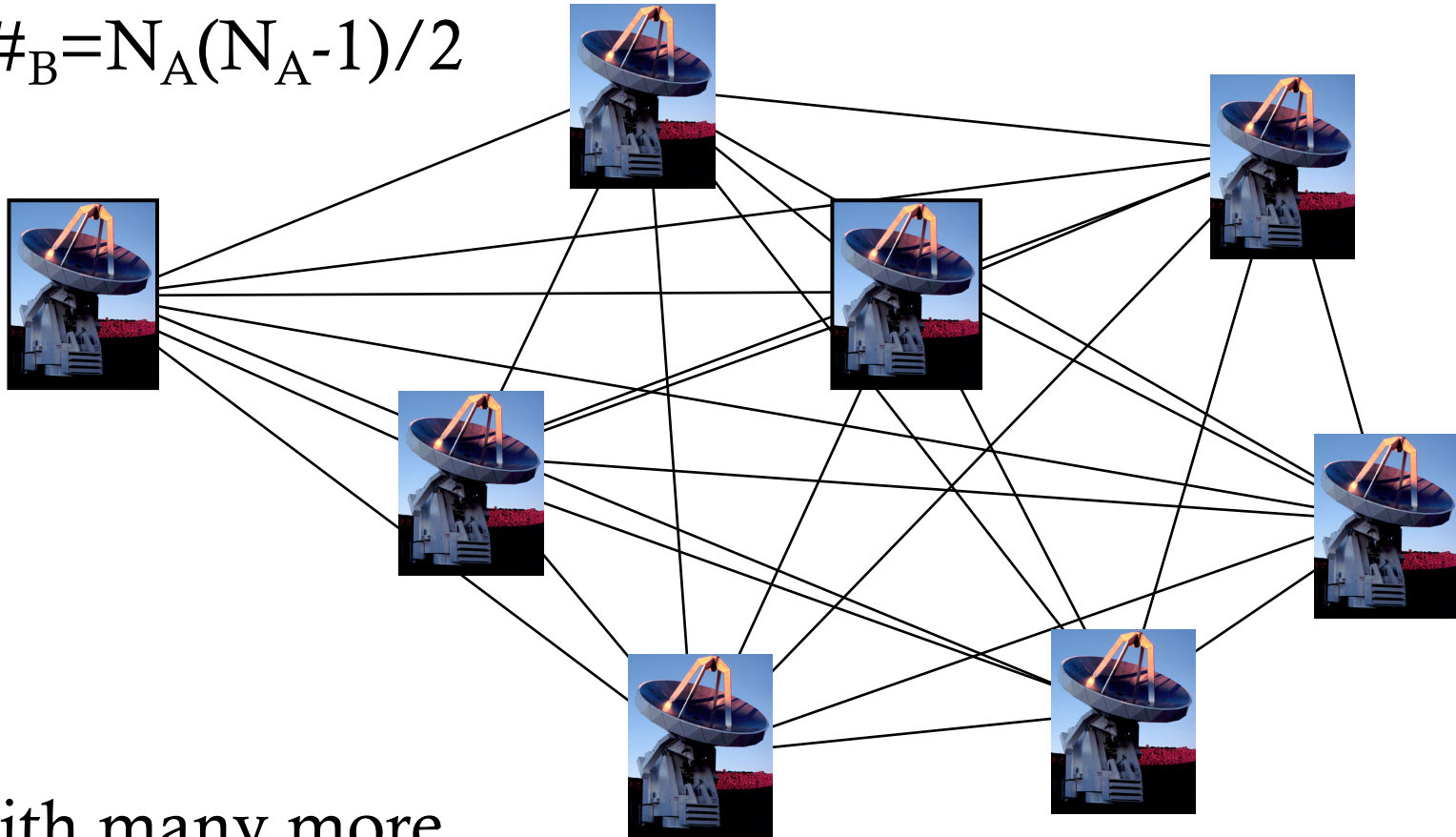

with many more
baselines. Since each $V_{M,jk}$ is noisy, formulating
antenna-based gains allows more precise corrections.

Gain Calibration in Practice (at the SMA)

1. T_{sys} Application
2. Passband (i.e. Spectral Response) Calibration
3. Phase Calibration vs Time
4. Amplitude Calibration vs (Time, Elevation)
5. Flux Calibration

Example Observation from 2018

8 Antennas, 1.3mm band

Raw Visibility Data (continuum, baseline 3-8)

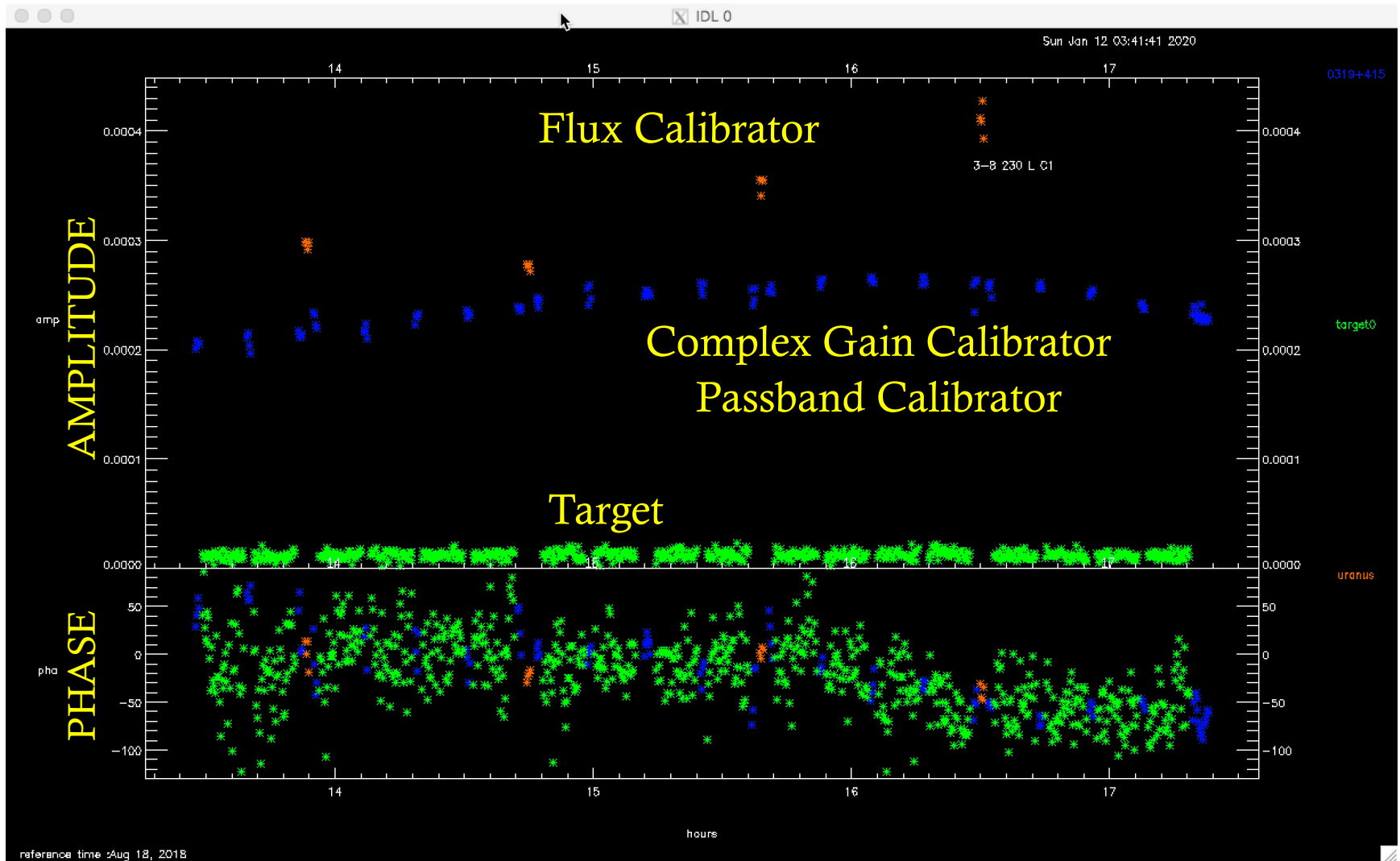

1. T_{sys} Application

Scales correlator output into flux density units, and provides 1st order correction for atmospheric opacity (elevation and time dependent).

ε = raw correlator output \sim fraction of signal correlated between two antennas

T_{sys}^* = system temperature, corrected to above atmosphere
 $= T_{\text{sys}} \times e^{\tau}$

G_A = forward gain of antenna(s); 130 Jy/K for SMA

$$F \sim \varepsilon T_{\text{sys}}^* G_A$$

T_{sys} Data (baseline 3-8)

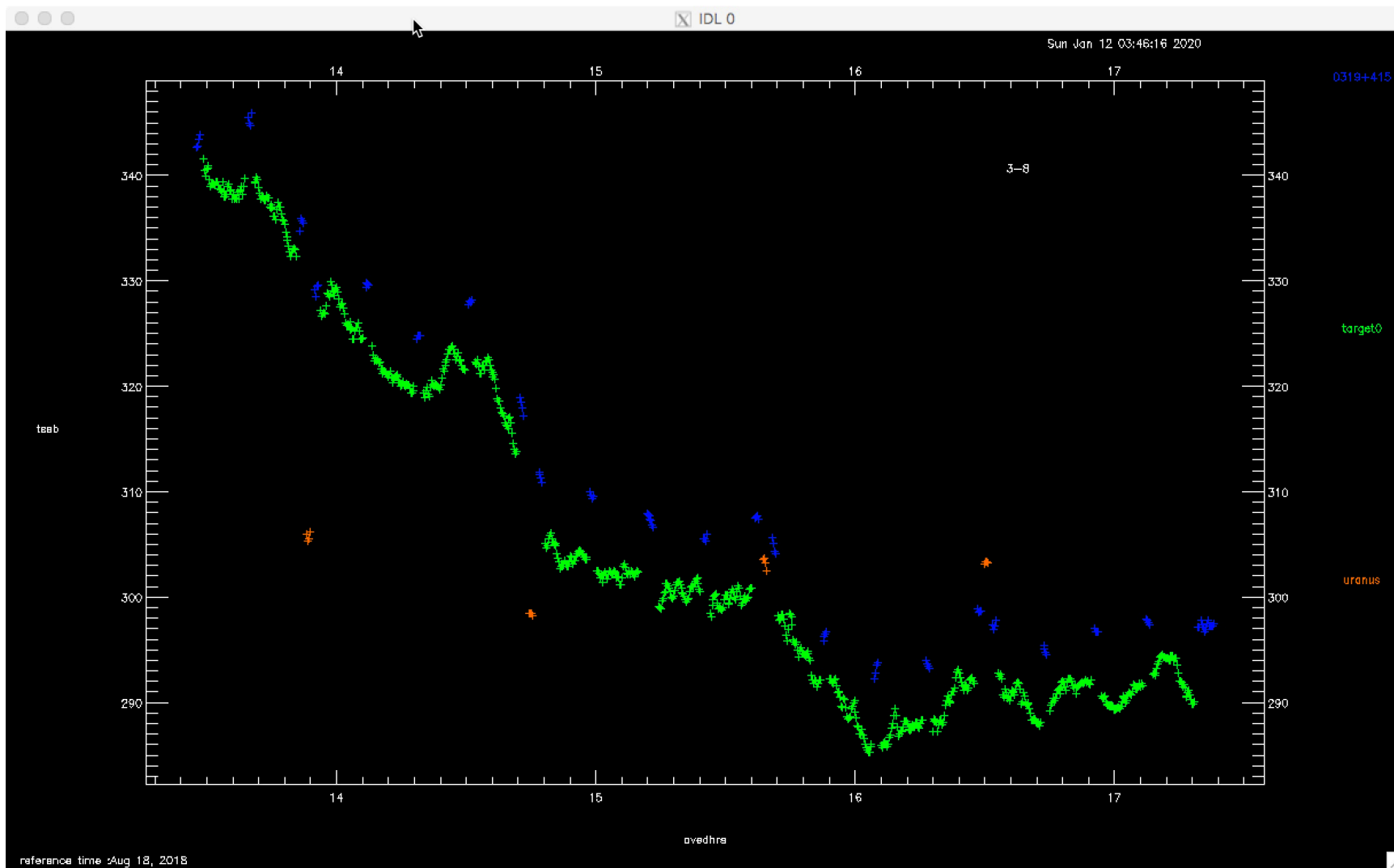

Vis. Data After T_{sys} Application (baseline 3-8) (using mir task 'apply_tsys')

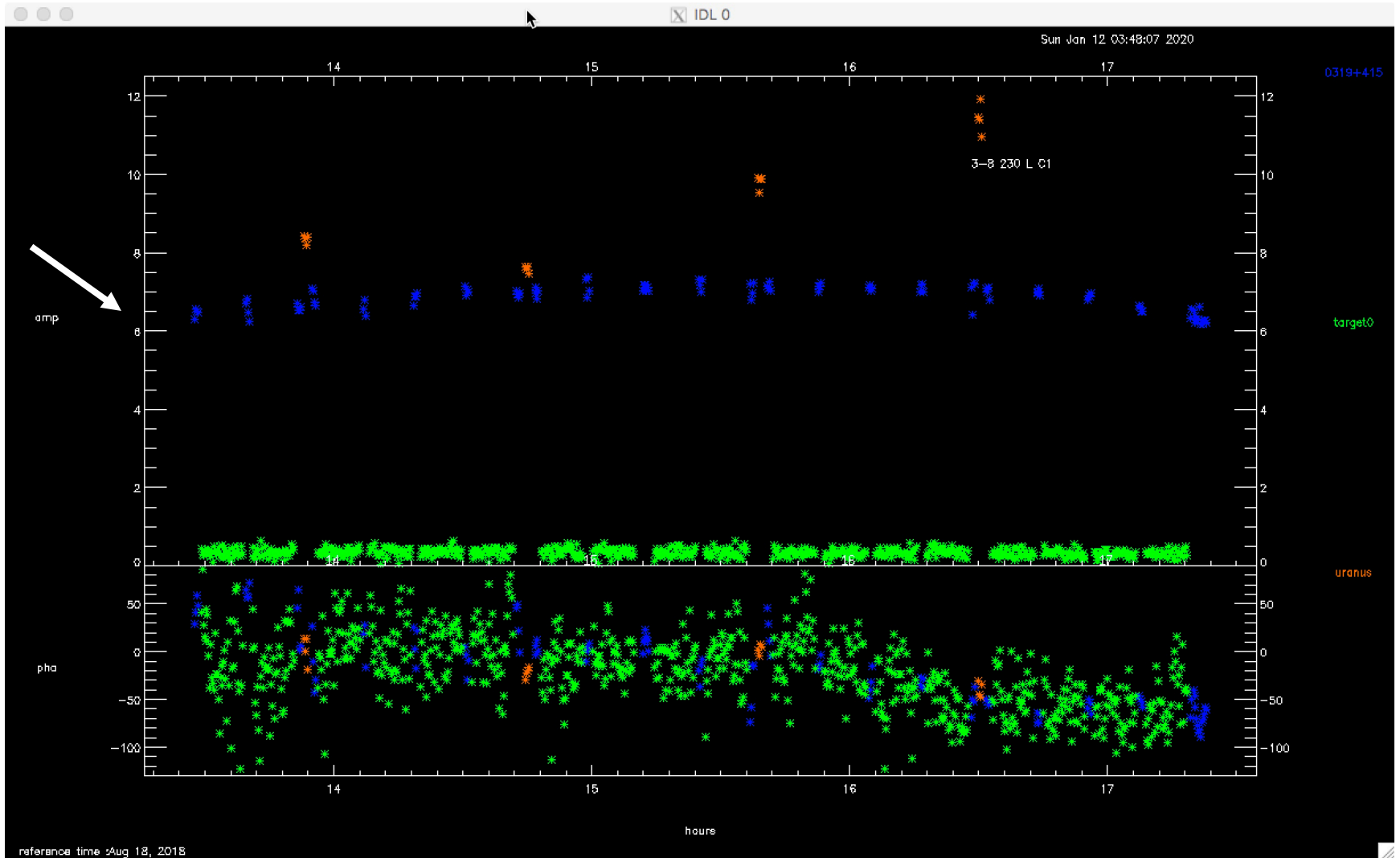

2. Passband Calibration

The spectral response of the interferometer over the IF is dominated by structure originating in the receiving and IF system (such as filter shapes). This response varies weakly, and slowly, with time; we generally assume* that the ‘passband gain’ is constant over an observation.

Passband gains can be determined via observations of strong compact sources (like a blazar such as 3C279 or 3C84) which are spectrally ‘flat’ over a few GHz.

Resolved objects ‘sometimes’ ok.

*assumption ignores atmospheric spectral features, like O₃, which vary with elevation, along with many other things.

Normalized raw spectrum of 3C84 (230Rx, LSB, baseline 3-8)

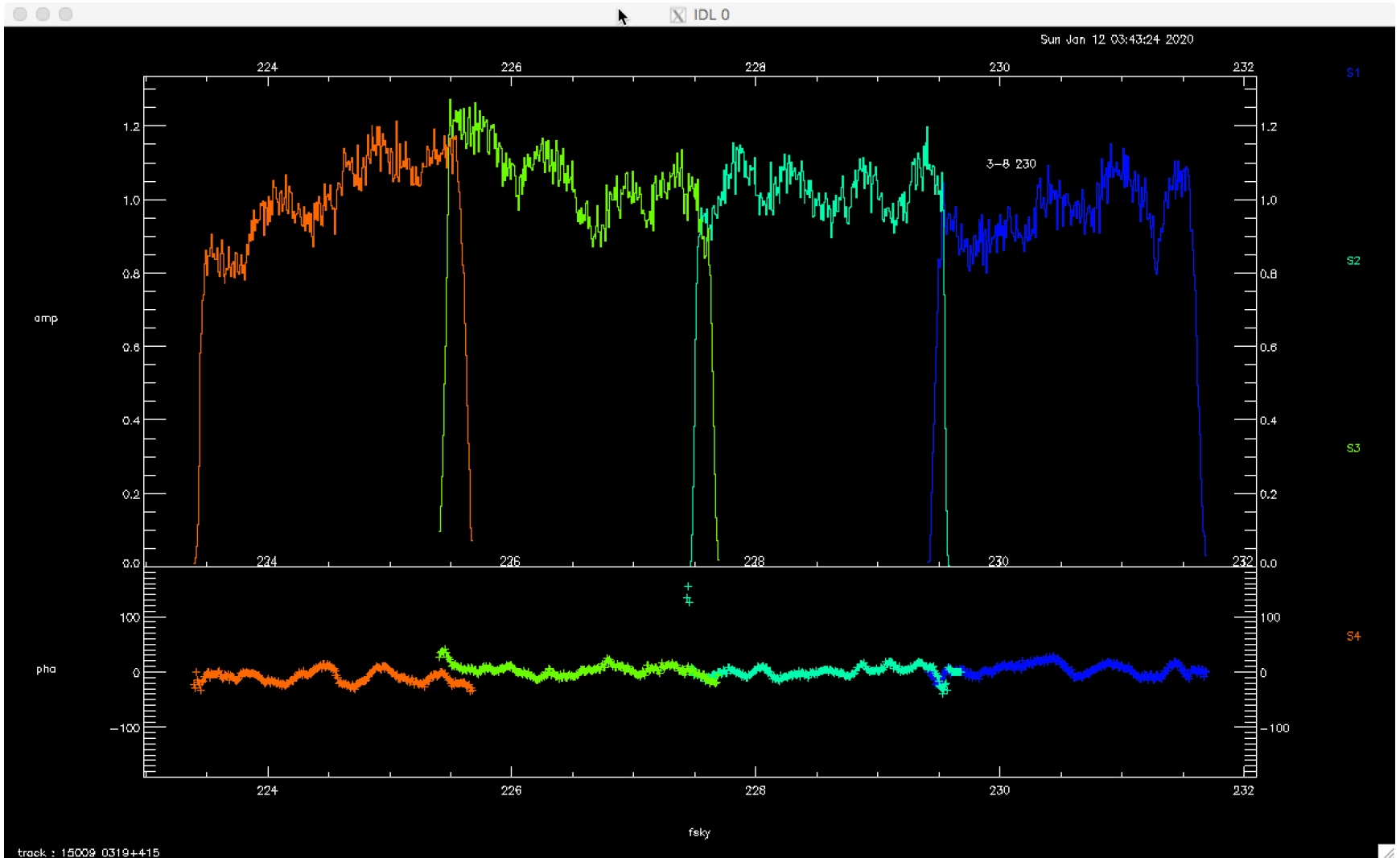

Antenna-based passband gain solutions, Ant 3 (using mir task 'pass_cal')

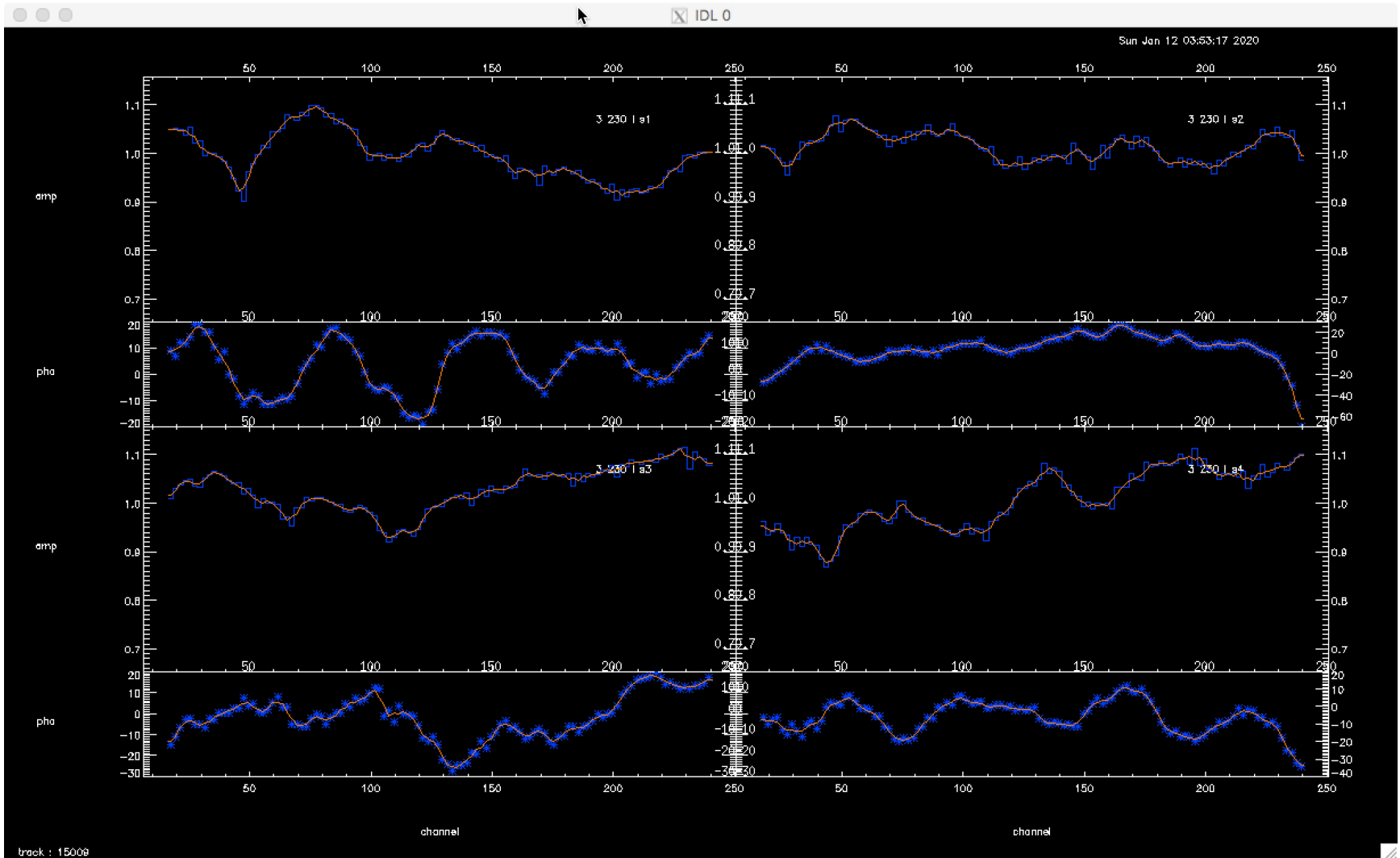

Antenna-based passband gain solutions, Ant 8 (using mir task 'pass_cal')

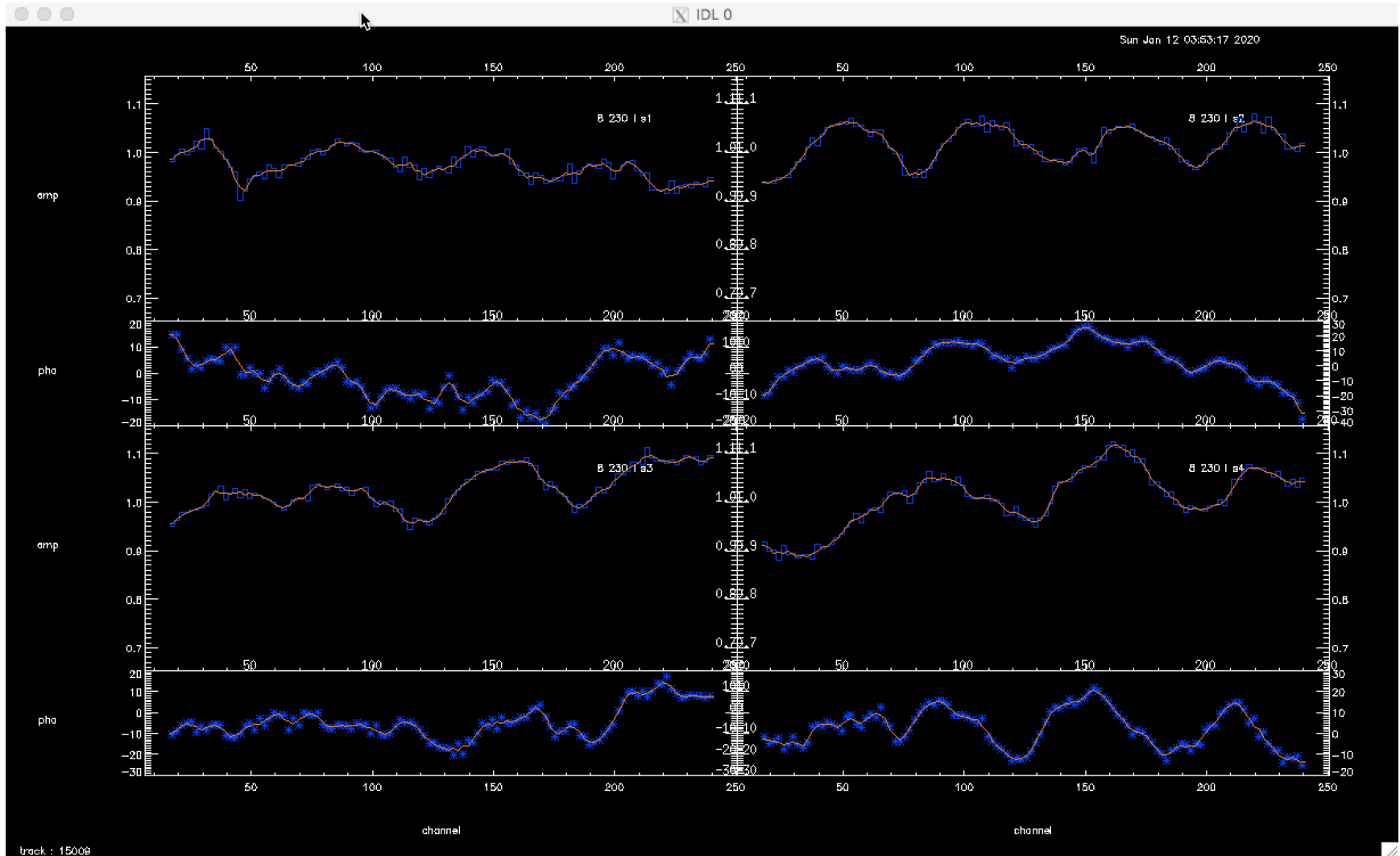

Normalized corrected spectrum of 3C84 (230Rx, LSB, baseline 3-8)

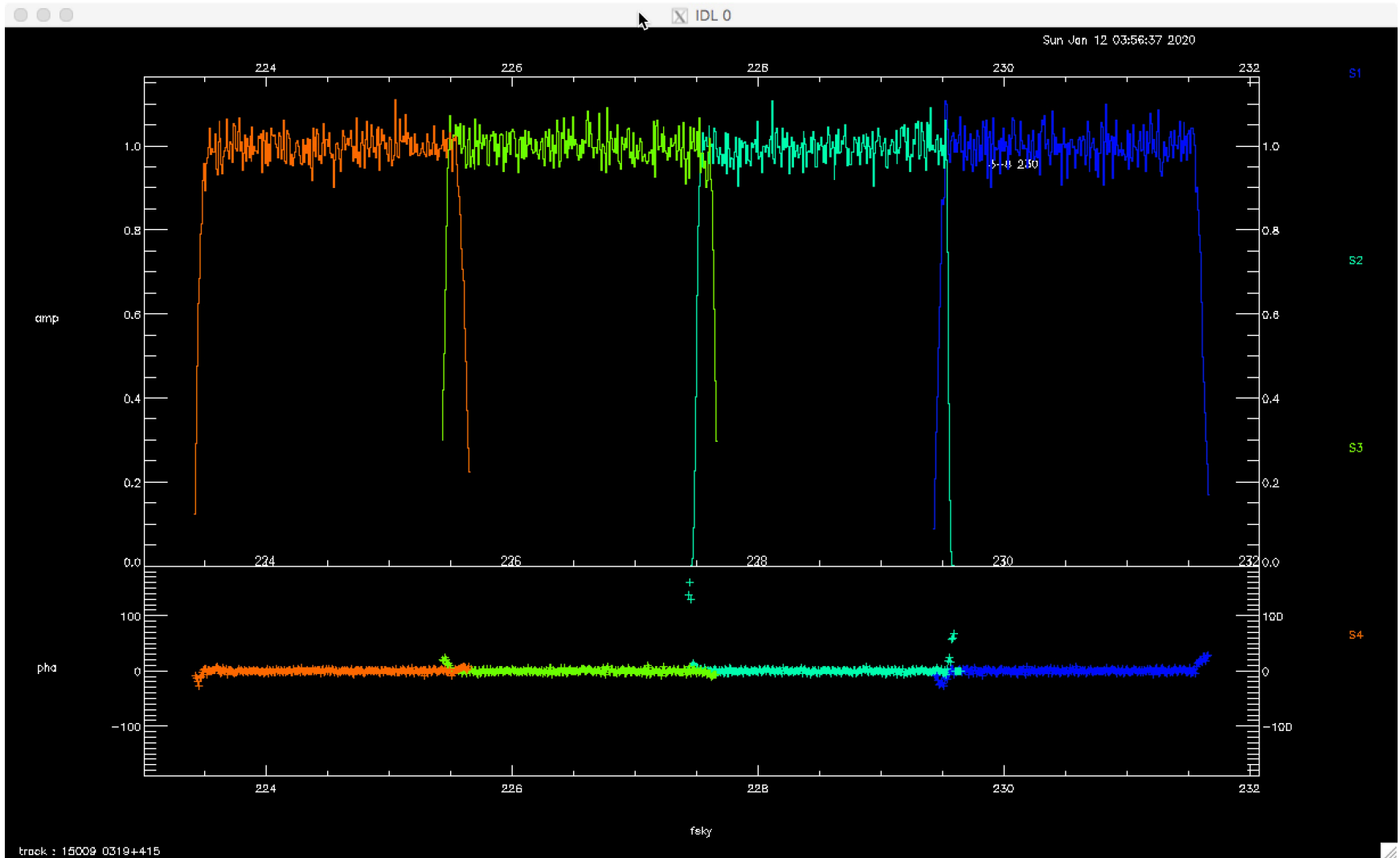

Normalized corrected spectrum of Uranus (230Rx, LSB, baseline 3-8)

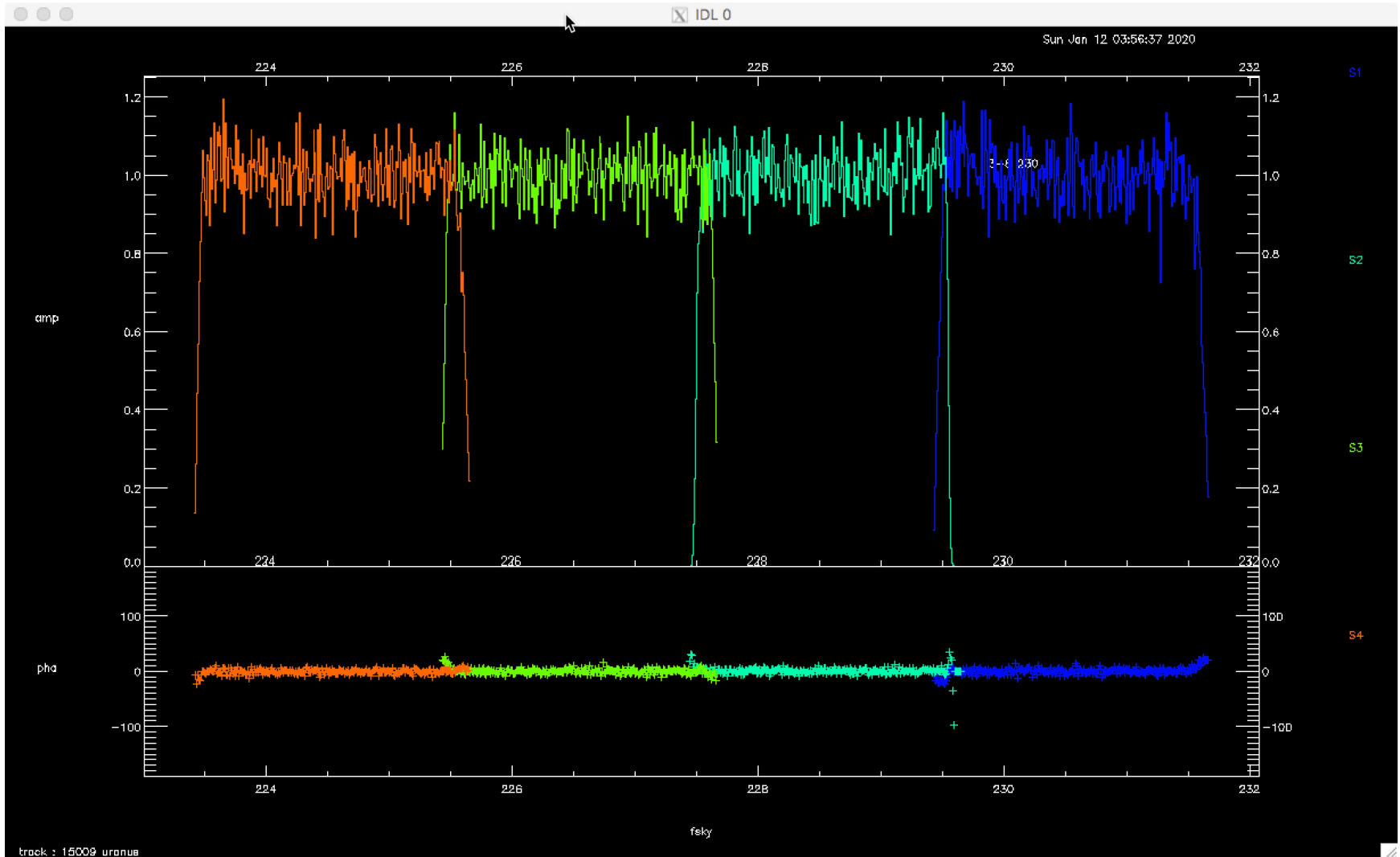

3. Phase Gain Calibration

Phase gain solutions are required to remove instrumental and atmospheric phase variability (typically with time) from the visibility data. Variability occurs on a variety of timescales in the atmosphere (e.g. Simon Radford's talk earlier).

Instrumental variability tends toward slow drifts, though abrupt 'jumps' can occur.

Complex gain calibrators are typically radio bright AGN, such as blazars, that are **effectively like bright point sources**. The closer to the target, the better (similar atmosphere).

1.3mm Band Flux Density Measurements

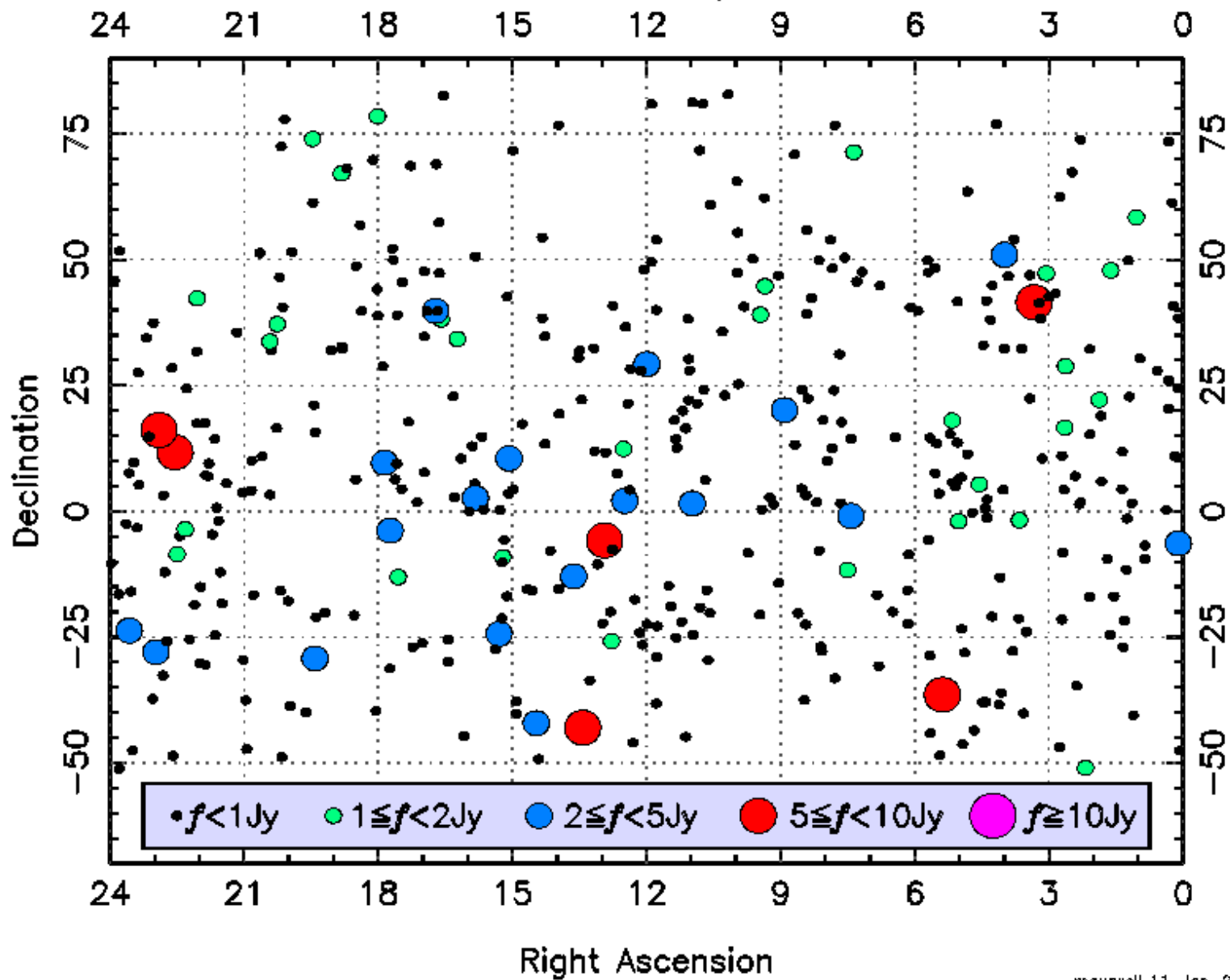

Phase gain solutions using 3C84, Ant 3 (using mir task 'gain_cal,cal_type='pha')

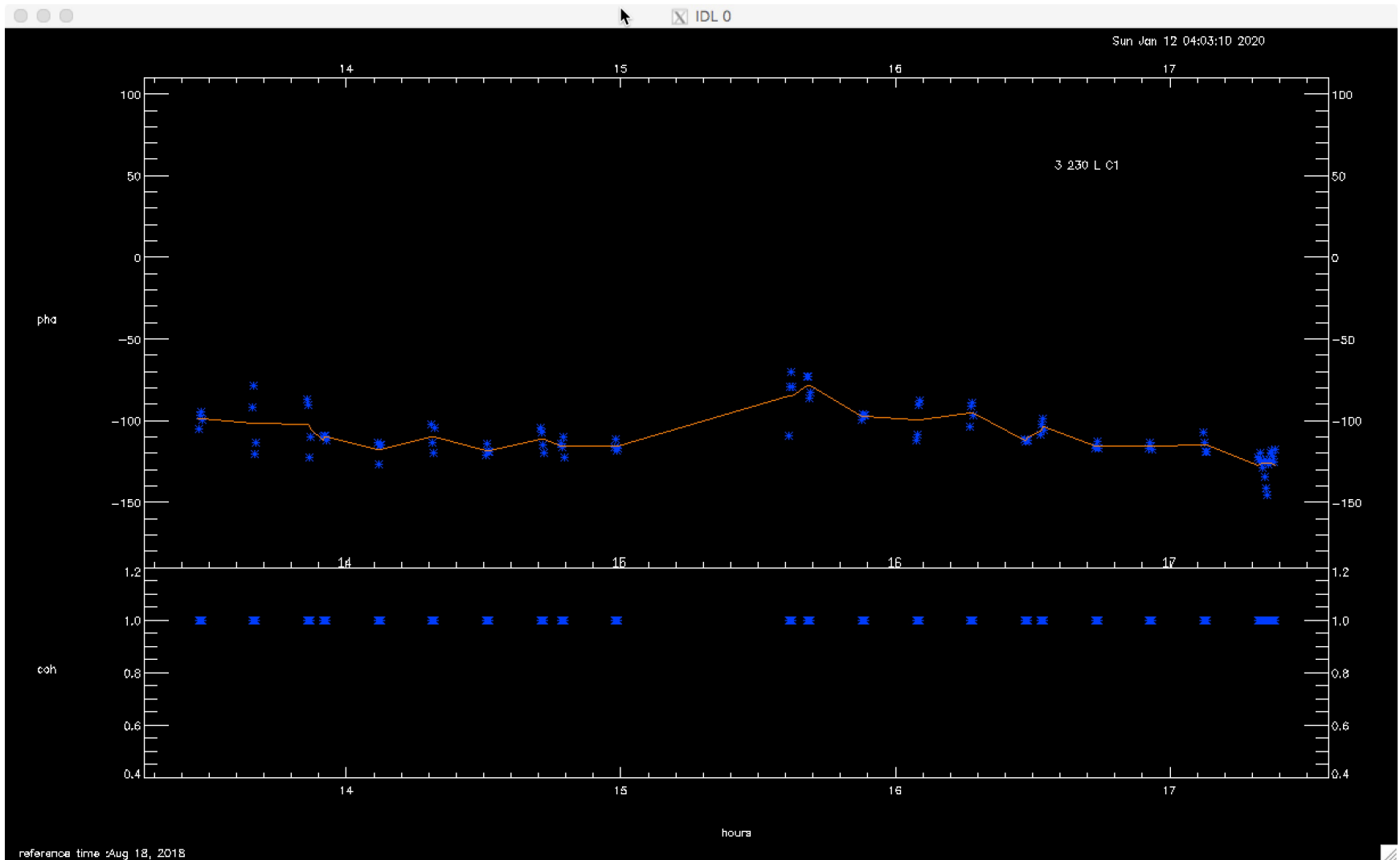

Phase gain solutions using 3C84, Ant 8 (using mir task 'gain_cal,cal_type='pha')

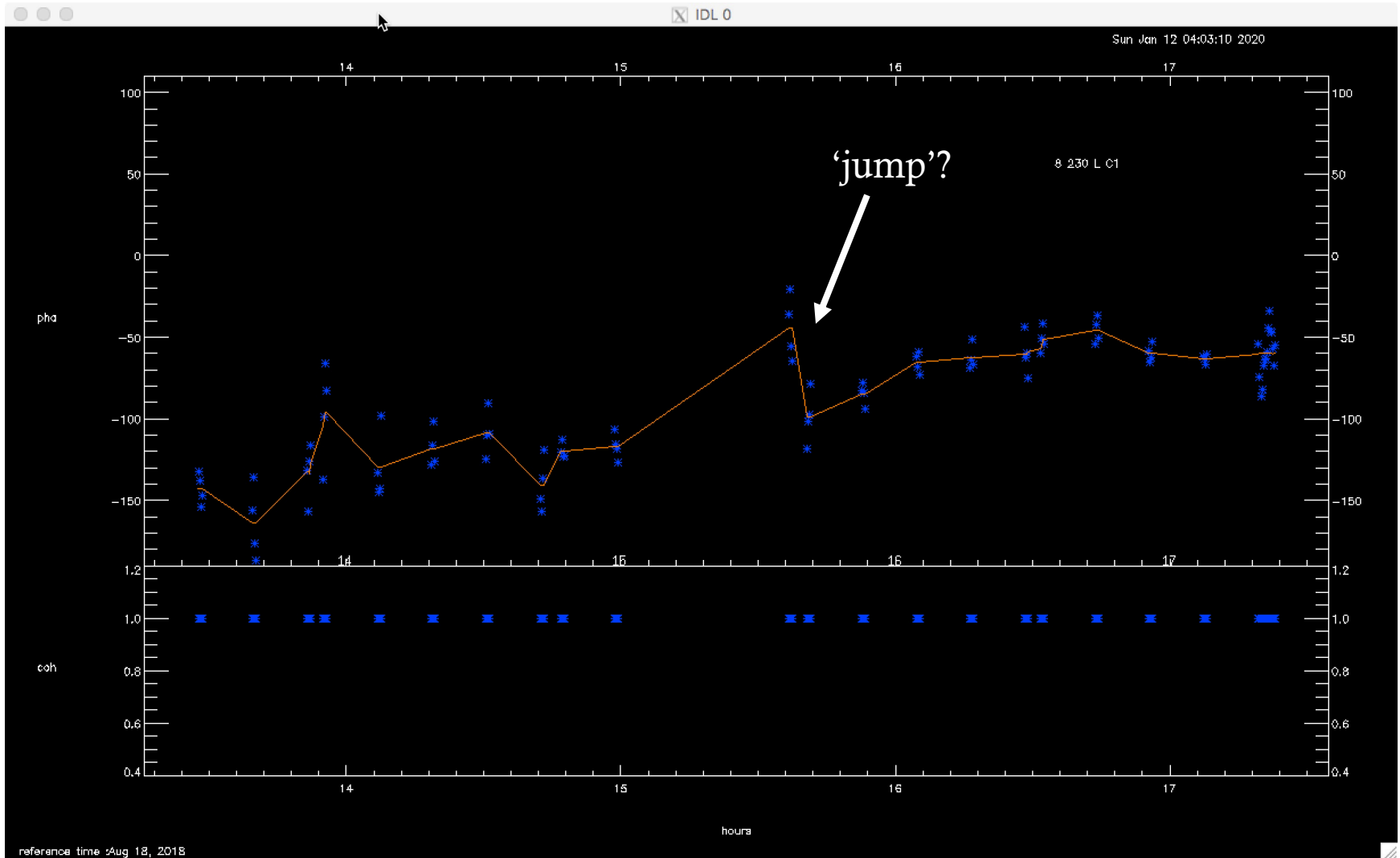

Vis. data after phase gain calibration (baseline 3-8)

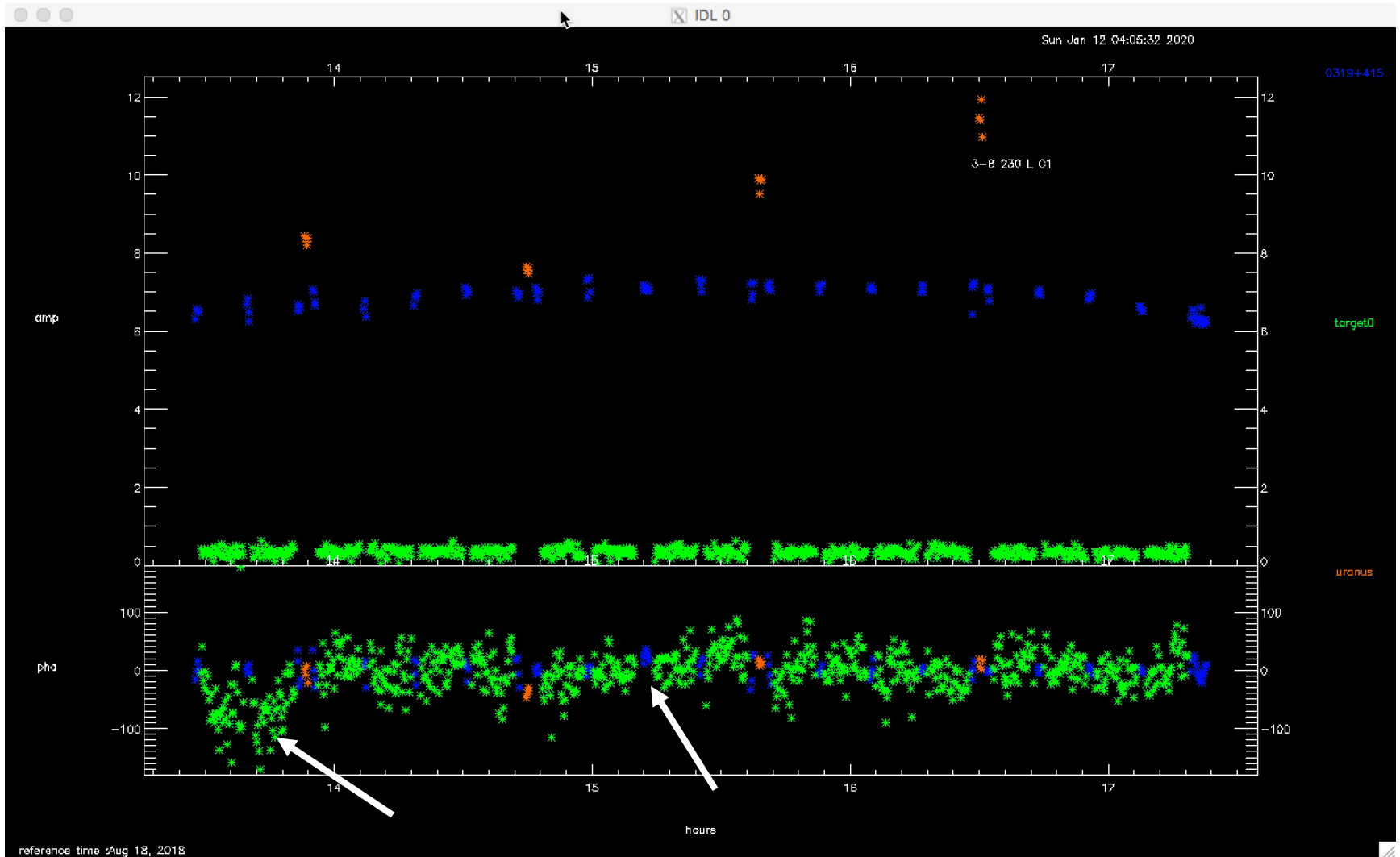

4. Amplitude Gain Calibration

Amplitude gain solutions are usually required to remove instrumental variability (for example, from a non-optimal antenna pointing model) and residual correction for atmospheric opacity from the visibility data. Variability occurs on a variety of timescales, but is generally slower than phase variability.

Complex gain calibrators are typically radio bright AGN, such as blazars, that are effectively like bright point sources. The closer to the target, the better (similar atmo.)

Amplitude gain solutions using 3C84, Ant 3 (using mir task 'gain_cal,cal_type='amp')

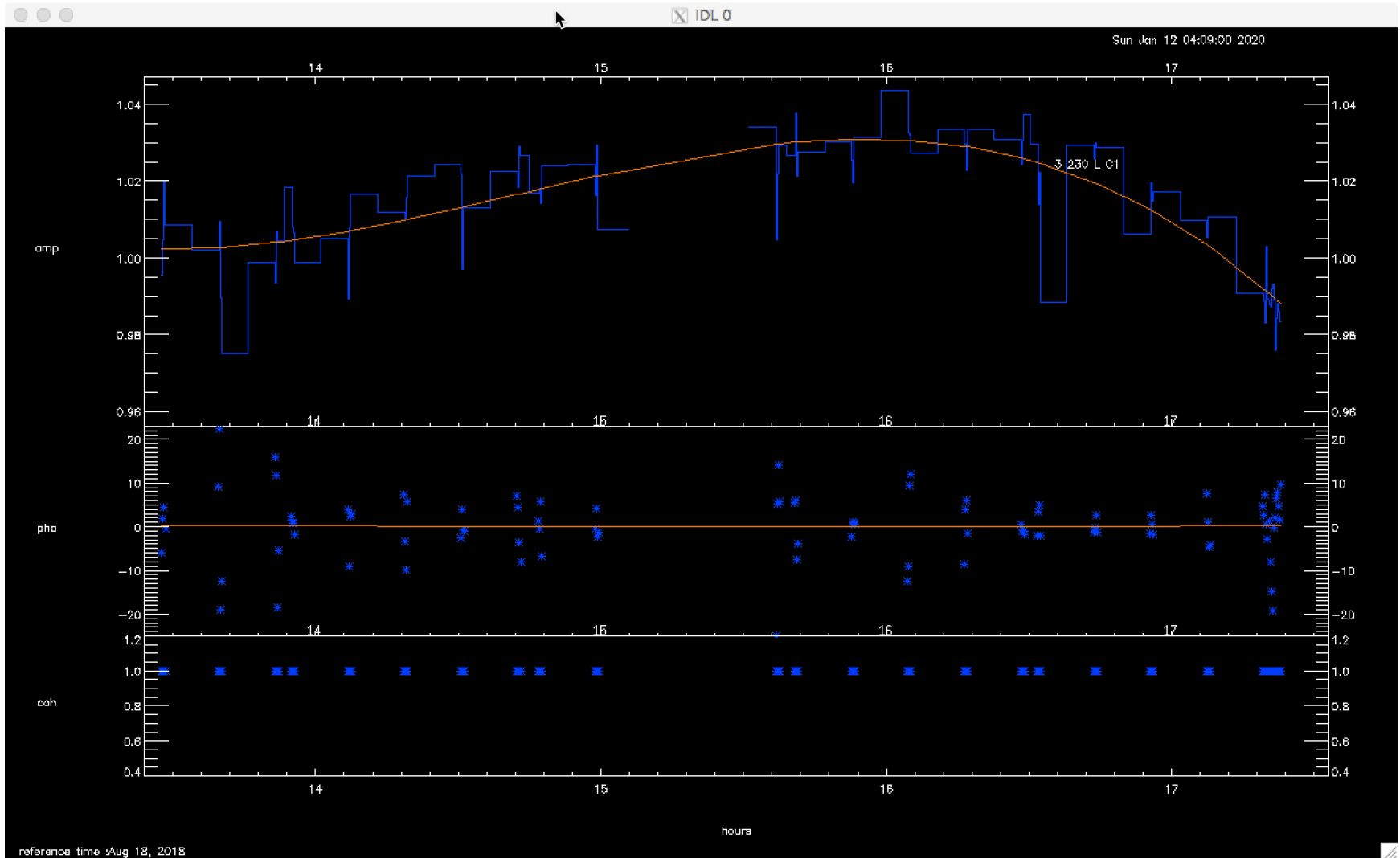

Amplitude gain solutions using 3C84, Ant 8 (using mir task 'gain_cal,cal_type='amp')

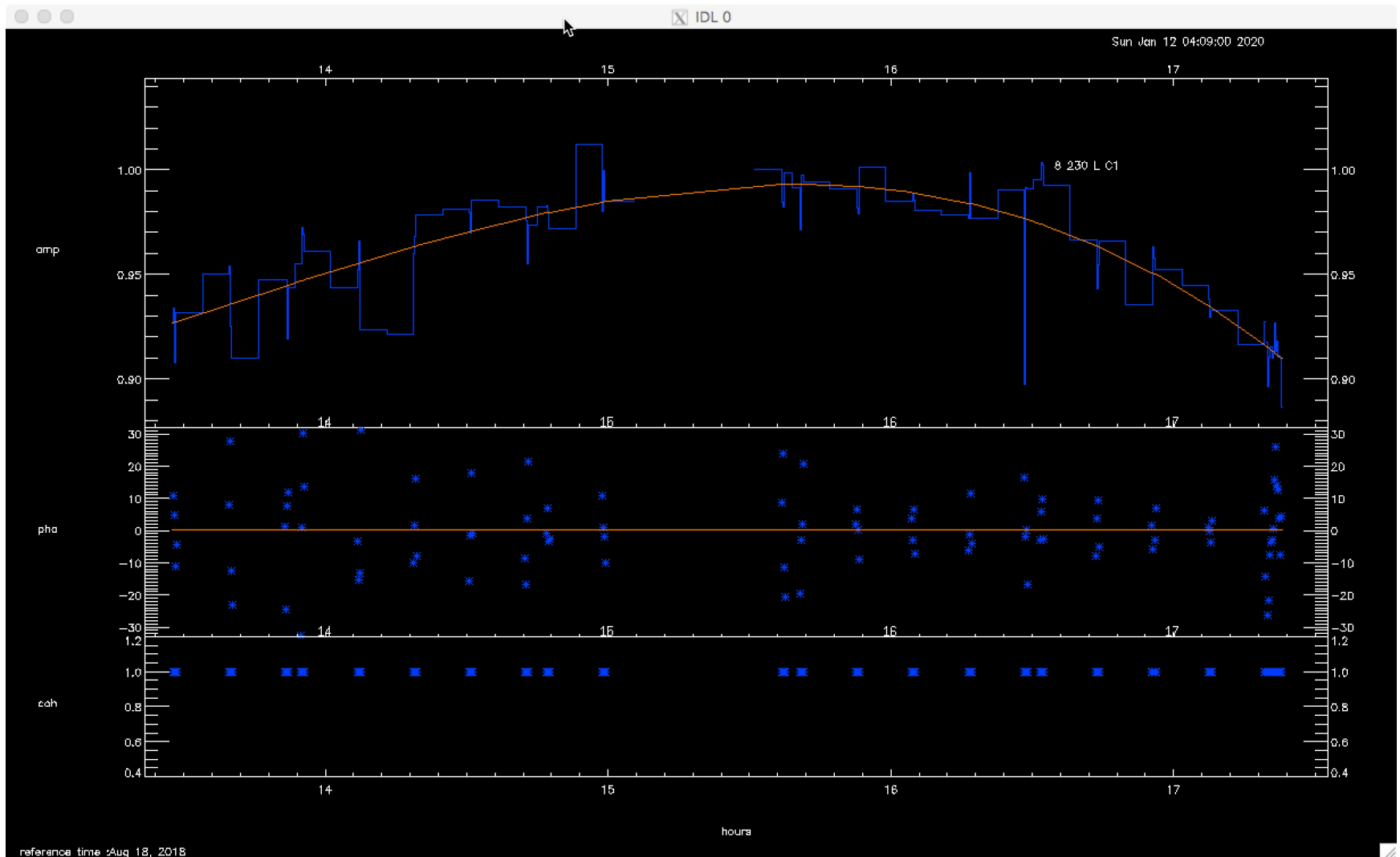

Vis. data after amplitude gain calib. (baseline 3-8)

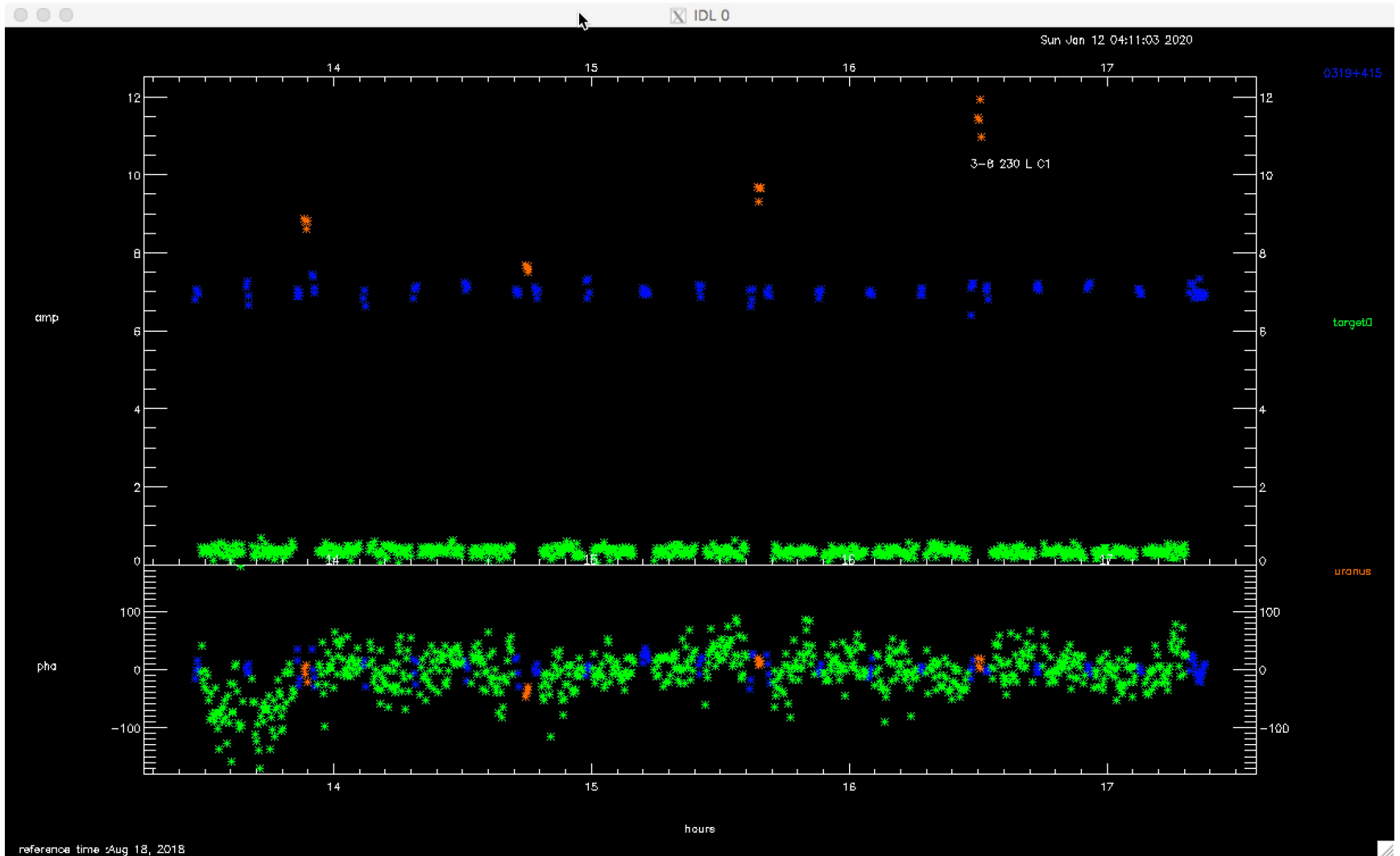

5. Flux Calibration

Flux calibration is required to properly place the visibility data onto a consistent scale; this is analogous to using standard stars in optical observing.

Flux calibrators are typically solar system sources. In the earlier days of mm astronomy, Mars and Jupiter were favored standards, but they are often heavily resolved by interferometers. Primary flux calibrators at the SMA are Uranus, Neptune, Ganymede, Callisto, and Titan. I will discuss flux calibration in more detail on Tuesday.

Vis. data after scaling by 1.23 (baseline 3-8)
(using mir task “gain_cal,cal_type=‘amp’,/nonpoint”)

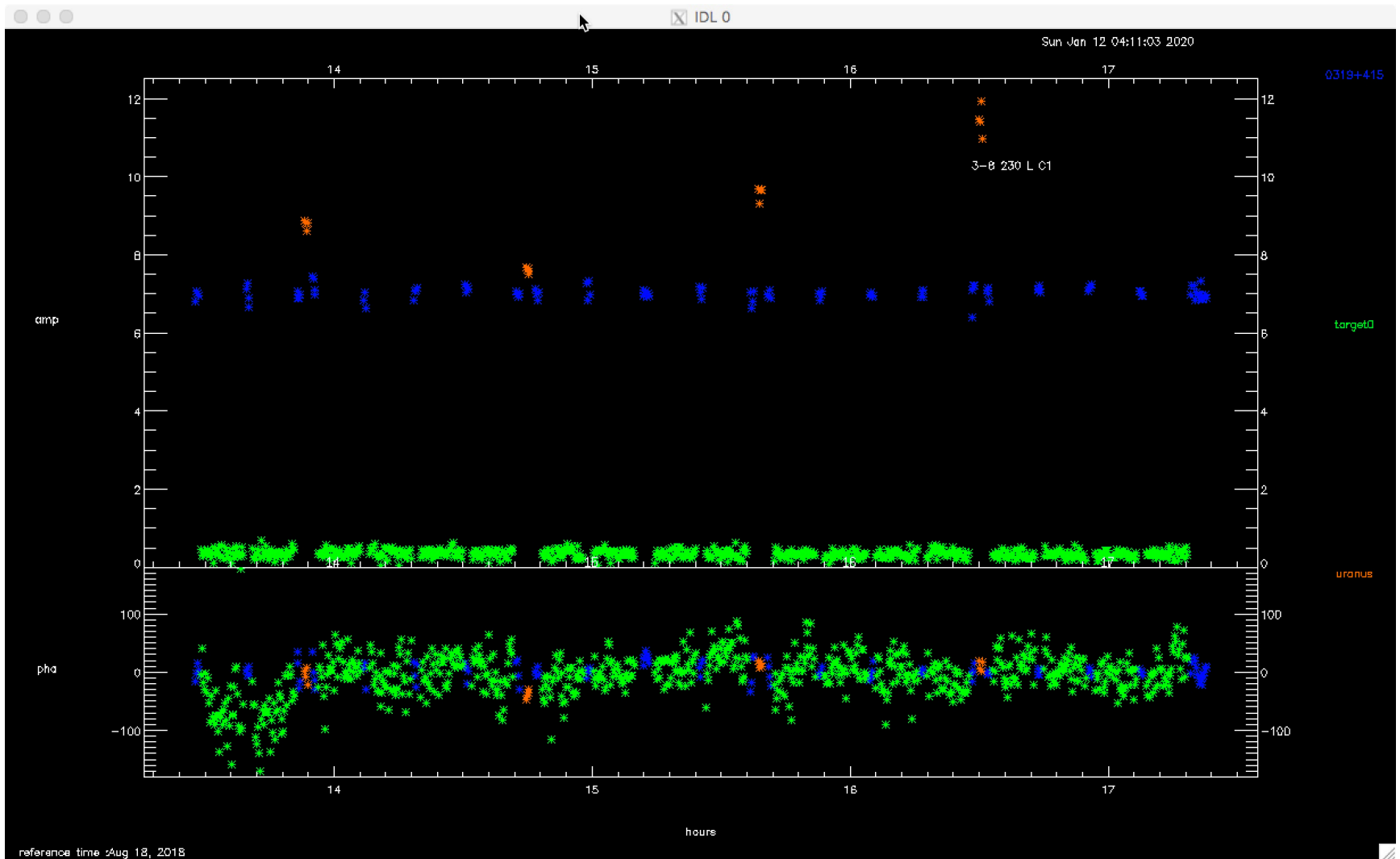

Gain Calibration Final Thoughts

These basic calibration concepts, in most cases, allow raw data to be transformed into science usable visibility data.

There are corner cases where there may be further calibration steps (such as application of updated antenna positions, as well as data editing to improve calibration outcomes).

Calibrated visibility data can be used directly (visibility analysis) or imaged through appropriate algorithms; these concepts will be discussed in upcoming talks.